

Simulating operational improvements on mine compressed air systems

BM Friedenstein

 [orcid.org 0000-0002-3041-6520](https://orcid.org/0000-0002-3041-6520)

Dissertation submitted in fulfilment of the requirements for the degree *Master of Engineering* in [Electrical and Electronic Engineering](#) at the North-West University

Supervisor: Dr JF van Rensburg

Graduation May 2018

Student number: 28354516

Abstract

Title: Simulating operational improvements on mine compressed air systems
Author: BM Friedenstein
Supervisor: Dr JF van Rensburg
School: North-West University Potchefstroom Campus
Degree: Master's in Electrical and Electronic Engineering

As the operational costs of deep-level mines increase and gold ore grades decrease, profitability in the South African gold mining sector is becoming a challenge. Electricity tariff increases moreover contribute to the rising cost of mining operations.

Compressed air supply systems are the most significant energy users in a mine; and they contribute to approximately 20% of the total power usage. Research has shown that these compressed air networks are systemically inefficient. Hence, improving the efficiency of these systems would result in a significant reduction in energy costs.

Previous studies have revealed the usefulness of simulations to improve deep-level mining systems. However, these studies did not follow a structured methodology for producing compressed air simulations and they used simplified compressed air models that reduced the simulation precision and testable scenarios. Recent developments in software allow for simpler and speedier development of complex system simulation models.

In this study, a simulation methodology was developed and investigations were conducted in respect of compressed air systems. A compressed air system was subsequently modelled in software to recreate the system operation accurately. Finally, a proposed means of improvement was simulated, analysed and quantified to enhance energy savings and service delivery.

Two case studies were evaluated. For each case study, various scenarios were simulated. In Case Study 1, two air network intervention scenarios were tested on a compressed air system. The results showed that energy cost savings of R0.91m could be achieved. The simulation results were very similar to tests later performed on the physical systems.

The results of Case Study 2 showed that by reducing air usage at refuge bays, an average power reduction of 1 megawatt (*MW*) could be achieved. The improvement in efficiency would potentially lead to R5.2m in annual energy cost savings. In addition, a significant improvement of 15 kPa in system pressure during the drilling period was identified. Other scenarios showed annual energy cost savings of up to R2.5m.

An additional analysis was performed to assess the use of periodically repeated simulations. The results demonstrated that operational changes in a system could be identified through repeated simulations. It would therefore be possible to use this information for further improvement and cost savings.

The study showed that a simulation is a valuable tool for identifying improvements in compressed air systems. By utilising a structured methodology to develop detailed compressed air simulations, inefficiencies and opportunities for operational improvements could be successfully identified.

Keywords: Compressed air, energy, mining, operational improvements, simulation

Acknowledgements

I would like to acknowledge the following people for their contributions towards the completion of my study:

- My wife Jeanne, as well as my parents Hugh and Jenni, for their support, understanding and encouragement
- Prof EH Mathews and Prof M Kleingeld for the affording me the opportunity to conduct this research
- Enermanage (Pty) Ltd, for their generous funding of the study
- Dr Philip Maré, for his mentorship and assistance
- My study leader, Dr JF van Rensburg for his expert guidance

Contents

Abstract	i
Acknowledgements	iii
Abbreviations and nomenclature	vi
List of figures and tables	viii
1 Introduction and background	1
1.1 Preamble	2
1.2 Background on deep-level mining	2
1.3 Compressed air systems in mining	4
1.4 Use of simulation in industry	6
1.5 Problem statement and objectives	9
1.6 Dissertation overview	9
2 Overview of simulation and compressed air applications	11
2.1 Introduction	12
2.2 Background on mining compressed air networks	12
2.3 Review of compressed air energy interventions in industry	16
2.4 Use of simulations to identify improvements in mining systems	22
2.5 Review of the use of simulation in compressed air optimisation	33
2.6 Conclusion	39
3 Developing a simulation methodology	40
3.1 Introduction	41
3.2 Investigate the system	41
3.3 Develop and verify a simulation model	44
3.4 Implement the simulation	57
3.5 Conclusion	60

4	Results and validation	62
4.1	Introduction	63
4.2	Case Study 1: Simulated improvements on mine A	63
4.3	Case Study 2: Simulated improvements on mine B	70
4.4	Case Study 3: Periodic simulation analysis	83
4.5	Potential benefit for South African mines	86
4.6	Conclusion	87
5	Conclusion	89
5.1	Preamble	90
5.2	Dissertation overview	90
5.3	Recommendations for future studies	91
	Bibliography	92
	Appendix I Simulation process flow schematics	99
	Appendix II Error Calculations	105
	Appendix III Model components verification	106
	Appendix IV Detailed mining level investigation diagrams	110

Abbreviations

CALDS	Compressed Air Leakage Documentation System
COLS	Corrected Ordinary Least Square
DCS	Dynamic Compressor Selection
DSM	Demand-Side Management
EE	Energy Efficiency
MAE	Mean Absolute Error
MRD	Mean Residual Difference
MSE	Mean Squared Error
p.a.	per annum
PC	Peak-Clip
PGM	Platinum Group Metal
PI	Proportional-Integral
PLC	Programmable Logic Controller
PTB	Process Toolbox
REMS	Realtime Energy Management System
RMSE	Root Mean Square Error
SCADA	Supervisory Control and Data Acquisition
SI	International System of Units
SP	Set-Point
THS	Thermal-Hydraulic Simulation
TOU	Time of Use
VFD	Variable Frequency Drive
VSD	Variable Speed Drive

Nomenclature

Celsius	SI measure for temperature	C
correlation coefficient	statistical measure of linear relationship between two variables	r
kilopascal	international measure of pressure	kPa
mass flow	measure of mass of a fluid moving per unit of time	kg/s
polytropic coefficient	thermodynamic coefficient used when describing the heat transfer due to compression or expansion	—
Rand	South African monetary unit	R
relative error	absolute error divided by the magnitude of the exact value.	$Err\%$
Stope	Void that is left after ore extraction	—
tonne	non-SI measure for 1000 kilograms	T
volumetric flow	measure of the volume of flow that moves per unit of time	m^3/s
Watt	SI measure of power	W

List of Figures

- 1.1 Electricity price increases compared to the inflation rate in South Africa . . . 2
- 1.2 Schematic representation of the mining processes 3
- 1.3 The percentage of energy consumption for each type of mining system 4
- 1.4 Simplified compressed air network model 7
- 1.5 Simplified system model 8

- 2.1 Schematic representation of a multi-stage centrifugal compressor 13
- 2.2 Example of a compressed air inlet in an underground refuge bay chamber of a mine 14
- 2.3 A typical operational schedule of a deep-level mine 15
- 2.4 The flow due to leakage as a function of inlet pressure and leakage area . . . 18
- 2.5 Illustration of a control valve 19
- 2.6 The compressed air energy and flow consumed per tonne of ore produced . . 21
- 2.7 Energy benchmark model for a mining compressed air system 23
- 2.8 The graphical interface of the PTB simulation tool 27
- 2.9 Example of simulation error calculations 31
- 2.10 Simulated energy consumption matrix 35
- 2.11 Compressor relocation simulation model 36
- 2.12 Simplified compressed air ring model 37
- 2.13 Simulation model for a complex air network 38

- 3.1 Flow diagram of the methodology for this study 41
- 3.2 Selecting boundaries for the simulation model 44
- 3.3 Interpolating input data to increase time-step resolution 46
- 3.4 Average summer surface ambient air conditions at a South African gold mine 46
- 3.5 PTB air boundary configuration interface 47
- 3.6 PTB air pipe configuration interface 48
- 3.7 Estimating the characteristic curve of a compressor by fitting a quadratic function to points of operation 49
- 3.8 PTB air compressor model configuration interface 50

3.9	Integrating the compressor component into the simulation	50
3.10	PTB air demand component configuration interface	51
3.11	Implementing flow demands and leaks into the simulation	51
3.12	Control components in Process Toolbox	52
3.13	Modelling the compressor control from a guide vane ¹	53
3.14	An example of a compressed air control valve	53
3.15	Example of two baseline periods, showing a changed compressor schedule . .	56
3.16	The periodic simulation process followed in this analysis	57
3.17	Theoretical example of a baseline vs. optimised power comparison	58
3.18	Eskom's weekday TOU tariff structure	59
3.19	Example of a simulation report submitted to mine personnel	60
3.20	Graphical representation of the methodology	61
4.1	Simplified process flow chart of the compressed air network	64
4.2	Average power profile	65
4.3	Simulated power compared to the actual measurement	67
4.4	Simulated flow compared to the actual measurement	67
4.5	Simulated pressure compared to the actual measurement	67
4.6	Energy savings by reducing compressor set-points	69
4.7	Scenario 2 - Simulated peak-time power reduction	69
4.8	Actual power savings achieved on the system	71
4.9	Process schematic of the compressed air network	73
4.10	Simulated power compared to the actual measurement	75
4.11	Simulated flow compared to the actual measurement	75
4.12	Simulated pressure compared to the actual measurement and set-points . . .	75
4.13	Addition of the refuge bay flow demands in the simulation model	77
4.14	Baseline system power compared to system power when refuge bay leaks were reduced	77
4.15	Baseline system pressure relative to system pressure when refuge bay leaks were reduced	78
4.16	Underground level simulation layout	80
4.17	Flow reduction during blasting period for 105 Level	81
4.18	Comparing simulated flow interventions on 105 Level	81
4.19	Energy saving achieved by general peak time station control	82
4.20	Flow, pressure and power error percentages for daily periodic simulations over a month	84

4.21	Supply efficiency and Compressor 1's average power output over the time of the periodic analysis	85
4.22	Comparison using alternative power sources	85
4.23	Gold and Platinum group metal mines in South Africa	86
I.1	Schematic representation of Mine A's compressed air simulation	100
I.2	Schematic representation of Mine B's compressed air simulation	101
I.3	Mine B simulation schematic – Compressors	102
I.4	Mine B simulation schematic – Surface air users	102
I.5	Mine B simulation schematic – Main shaft air users	103
I.6	Mine B simulation schematic – Sub-shaft air users	104
IV.1	105 Level investigation – Station	111
IV.2	105 Level investigation – West operations	112
IV.3	105 Level investigation – East operation	113

List of Tables

- 1.1 Summary of energy-saving estimation rules 7
- 2.1 Results of the comparison of verification methods 31
- 2.2 Simulation verification methods implemented in previous studies. 32
- 2.3 Summary of reviewed compressed air simulation studies 33
- 2.4 Summary of shortcomings in previous compressed air simulation studies . . . 39
- 3.1 The input parameters for the after-cooling simulation model 54
- 4.1 Data inputs and outputs for the Case Study 1 simulation model 66
- 4.2 Case Study 1: Verification of simulation model 68
- 4.3 Comparison of Mine A’s simulated scenarios 70
- 4.4 Simulation inputs and outputs 74
- 4.5 Verification of simulation model 76
- 4.6 Comparison of the simulated scenarios 82
- 4.7 Data inputs and outputs for the simulation 83
- II.1 Error calculation input data 105
- III.1 Case Study 1: Simulation model verification tables 107
- III.2 Case Study 2: Simulation model verification 108
- III.3 Case Study 2: Simulation model verification continued 109

CHAPTER 1

Introduction and background

“Precisely one of the most gratifying results of intellectual evolution is the continuous opening up of new and greater prospects.” - Nikola Tesla

1.1 Preamble

Chapter 1 starts off by discussing the background of deep-level mining in South Africa. Next, it examines the need to reduce operational costs. It focuses on reducing the energy consumption of compressed air systems and it attends to compressed air operation and energy interventions. Simulations and their value in the industry are reviewed, and this leads to a statement of the problem and the objectives of the study. The chapter concludes with an overview of the dissertation.

1.2 Background on deep-level mining

1.2.1 Mining profitability

Various technical, economic, social and operational challenges pose a risk to the profitability of the South African mining sector. One of the challenges faced by the sector is a rise in the cost of operations [1].

Another factor that has in recent years contributed considerably to the increase in operational costs in South African gold mines is electricity costs. As shown in Figure 1.1, the general cost of electricity has increased at a rate higher than inflation since 2008¹.

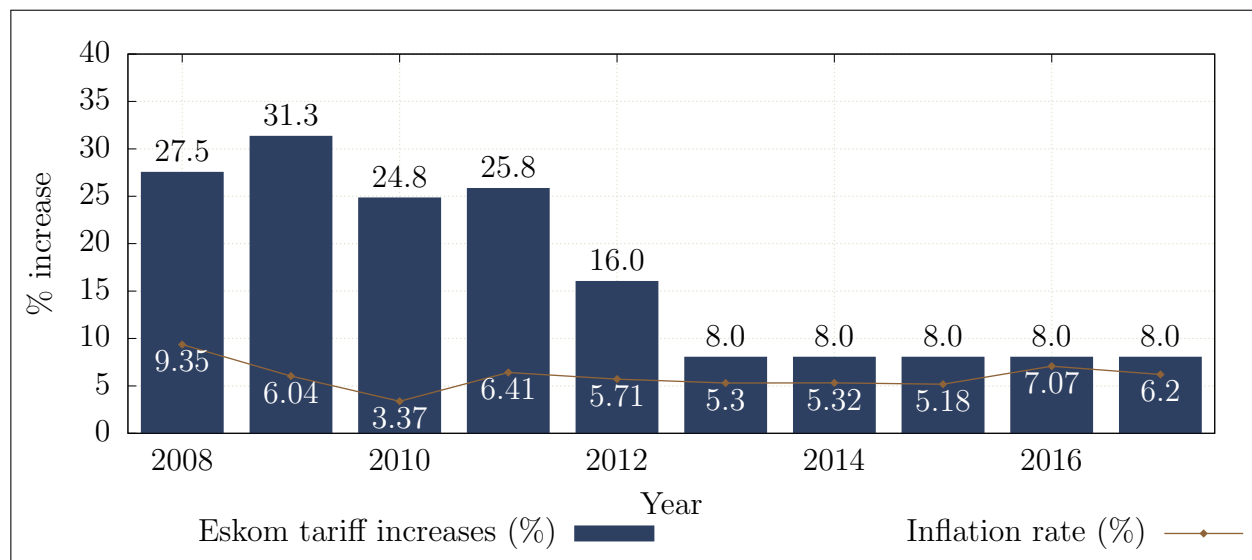

Figure 1.1: Electricity price increases¹ compared to the inflation rate in South Africa² between 2007 and 2017

¹ Eskom, “Revenue application – multi-year price determination 2013/14 to 2017/18 (mypd3),” [Online] <http://www.eskom.co.za/CustomerCare/MYPD3/Documents/NersaReasonsforDecision.pdf>, 2013, [Accessed 22 March 2017].

² inflation.eu, “Historic inflation South Africa,” [Online] <http://www.inflation.eu/inflation-rates/south-africa/historic-inflation/cpi-inflation-south-africa.aspx>, [Accessed 25 March 2017].

In addition to rising electricity costs, gold ore grades of South African mines have fallen substantially in recent decades [2]. As ore grades decline, the energy utilised per unit of metal increases exponentially [3].

Furthermore, mines need to extend their operations deeper into the earth to reach the valuable ore reefs¹. Therefore, mines require significantly more energy per unit of metal produced. This combination of tariff increases and increased energy usage per unit has led to a significant rise in mining operation costs.

1.2.2 Process of a deep-level mine

South Africa's mines are some of the deepest in the world. Some mine shafts are reaching depths greater than 4000 m below the surface [4]. The process of extracting ore at this depth is dependent on a number of essential services, mainly cooling and ventilation, pumping, compressed air and hoisting (see Figure 1.2).

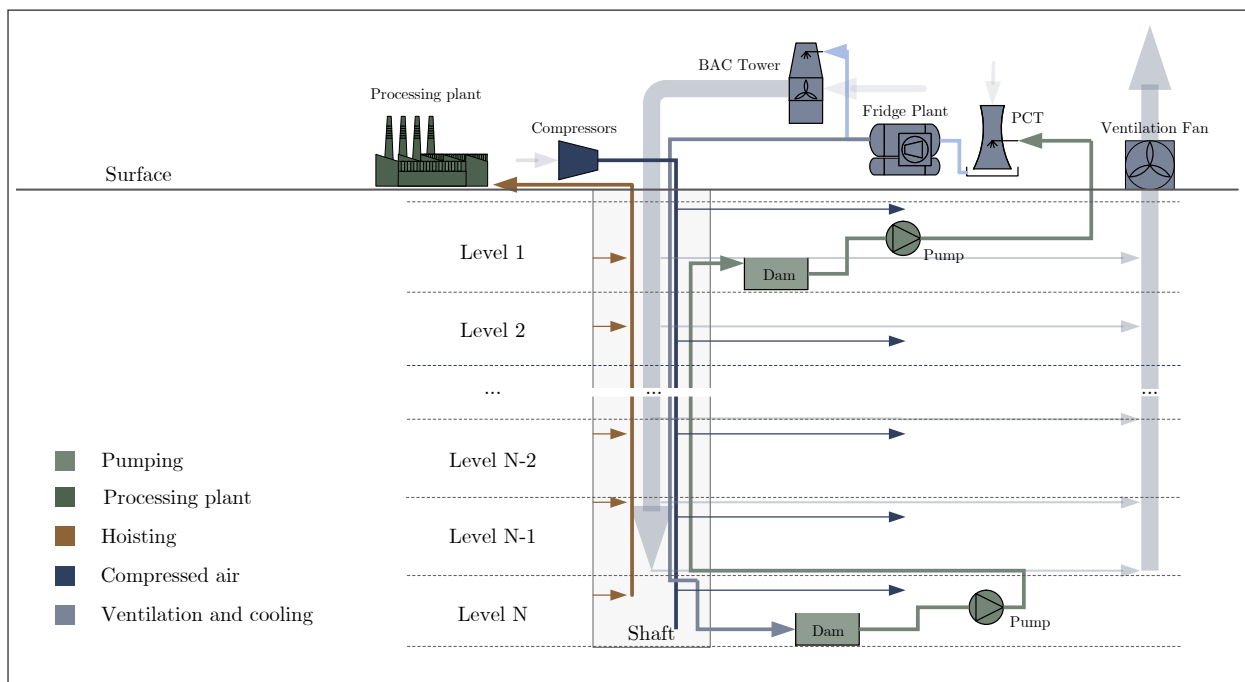

Figure 1.2: Schematic representation of the mining processes

Cooling and ventilation systems are required to maintain a safe working temperature underground. Pumping is critical to remove service and fissure water, as well as to prevent flooding. Compressed air is used to power underground drills and machines, as it is safer than other available energy sources for in-stope drilling. Because these drills operate using air, there is no added risk for fire.

¹ Wall Street Journal, "SA Miners Dig Deeper to Extend Gold Veins' Life Spans," [Online] <https://www.wsj.com/articles/SB10001424052748703584804576144062424424614>, [Accessed 25 March 2016].

A hoisting system is needed to bring the ore to the surface and to transport workers inside the mine. The hoisted materials are transferred to a plant for processing.

1.2.3 Energy usage of mining services

In South Africa, the mining industry utilises approximately 15% of the national electricity supplier’s annual output, of which gold and platinum mines use close to 80%¹. Figure 1.3 illustrates the division of energy use within the mining industry. The chart indicates that compressed air systems utilise the biggest amount of energy within a mine. Due to the low efficiency and high energy usage of these systems, energy use can be reduced most effectively when energy-saving interventions are implemented in respect of compressed air systems.

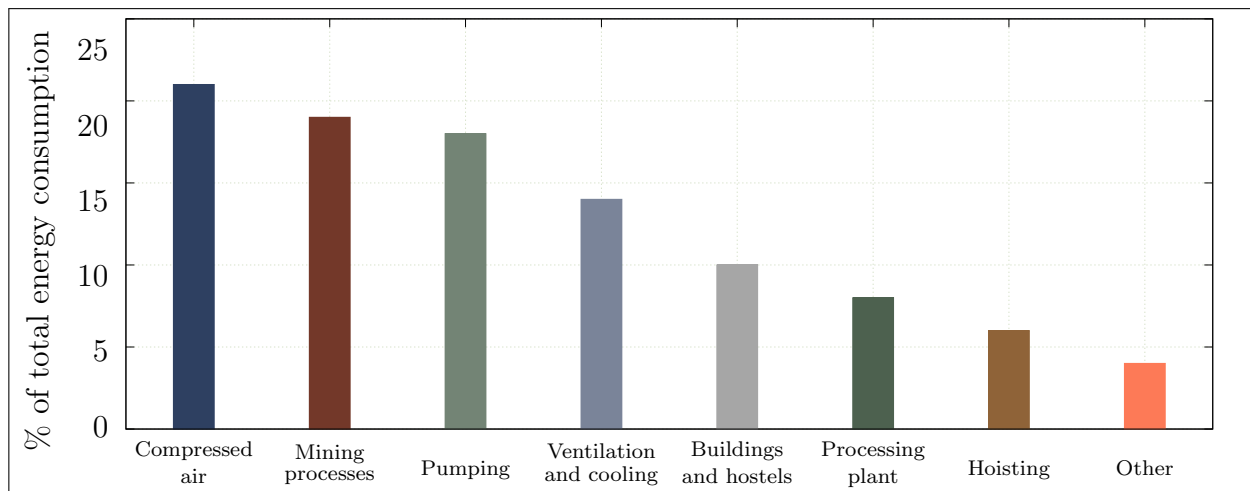

Figure 1.3: The percentage of energy consumption for each type of mining system [5]

1.3 Compressed air systems in mining

1.3.1 Compressed air in operation

Primarily due to their reliability, versatility and ease of use, the South African mining industry has installed extensive compressed air networks. These systems can have compressors with capacities of up to 15 megawatt (*MW*)[6]. However, the supply of compressed air is a high-energy-demanding and costly process [7].

The energy used for compressed air production amounts to between 9% and 20% of the total mining energy consumption¹ [8]. Unfortunately, the compression process is highly inefficient and [9] and [22] have shown that the efficiency of the process of converting electrical energy to power pneumatic drills is as low as 4% and between 5% and 20% respectively. The efficiency

¹ Eskom, “The energy efficiency series - towards an energy efficient mining sector,” [Online] <http://www.eskom.co.za/sites/idm/Documents/121040ESKD>, February 2010, [Accessed 19 March 2017].

of these machines is quite low when compared to alternative rock drills such as electric, oil, electro-hydraulic and hydro-powered drills that convert energy at an efficiency of between 20-31% [9], [13].

Sizeable compressed air systems are largely inefficient. Internationally, the expected energy-savings potential of large compressed air networks has been proven to be 15% [10]. Marais [11] calculates that energy-efficiency improvements could lead to energy and cost savings of between 30% and 40%.

1.3.2 Inefficiencies found in compressed air systems

Compressed air distribution networks in the mining industry consist of multiple compressors and working areas are up to eight kilometres away from the source on the surface [6]. Due to their size and complexity, these systems are prone to significant energy losses [6].

Compressed air leakage accounts for as much as 35% of the energy losses of a compressed air network [12]. Other systemic losses include faulty valves, pipe diameter fluctuations, obstructed air compressor intake filters and inefficient compressors.

Leakage and inefficiency detection strategies are not commonly pursued in the South African mining industry [13]. However, many mines do perform leak inspections either internally or by an outside company. In these inspections, an ultrasonic detector is often used to locate the leak. Alternatively, some mines employ the “walk and listen” method to identify leaks from the audible sound that they produce [13]. Once the inspection has been completed, the findings, including the locations and estimated cost of all identified leaks, are reported.

1.3.3 Compressed air savings interventions

In Chapter 2, successful compressed air interventions on mining systems is discussed on the basis of a literature review. The available literature reports that energy-saving interventions on compressed air systems implemented one or a combination of the following strategies [14]:

- Reducing leaks
- Reducing demand
- Reducing unauthorised air usage
- Increasing supply efficiency
- Optimising supply

A combination of energy strategies often leads to the most savings [6].

Once an energy-saving measure has been identified, it is necessary to make estimations to determine the potential costs and benefits of the intervention. The estimations are typically performed using first principle calculations, simplified mathematical models and practical tests where possible.

However, new tools have enabled the quick and accurate development of a compressed air model. Through simulations, accurate estimations can be obtained quickly, with no risk and at comparatively low resource requirement.

1.4 Use of simulation in industry

1.4.1 Background on industrial simulation

Continuous improvement in computing hardware have led to major advancement in software technology. Consequently, computational simulation has become an increasingly valuable tool to be used in many industries [15].

In *Handbook of Simulation: Principles, methodology, advances, applications, and practice*, [16] the following advantages of the use of simulation in the industry are listed:

- The ability to test new policies, operating procedures and methods without disrupting the actual system.
- The means to identify problems in complex systems by gathering insight about the interactions within the system.
- The facility to compress or expand time to investigate phenomena thoroughly.
- The capability to determine the limits and constraints within a system.
- The potential to build consensus about proposed designs or modifications.

1.4.2 Simulation usage in compressed air optimisation

Simulation is used to test and identify energy and operational improvement modifications in mining compressed air systems. However, in the past the production of complex models for mining systems was not feasible as the simulation software was too cumbersome for use in large compressed air systems and often required often unattainable data inputs [11].

Simplified “vessel” model

Before new software tools allowed for the development of detailed mining compressed air simulation models, Marais [6], [11] created a simplified compressed air model to estimate and quantify the performance of potential energy interventions. Marais simplified the mining

compressed air system, and compared the network to an air source and a vessel with many leaks. The simplified model is illustrated in Figure 1.4.

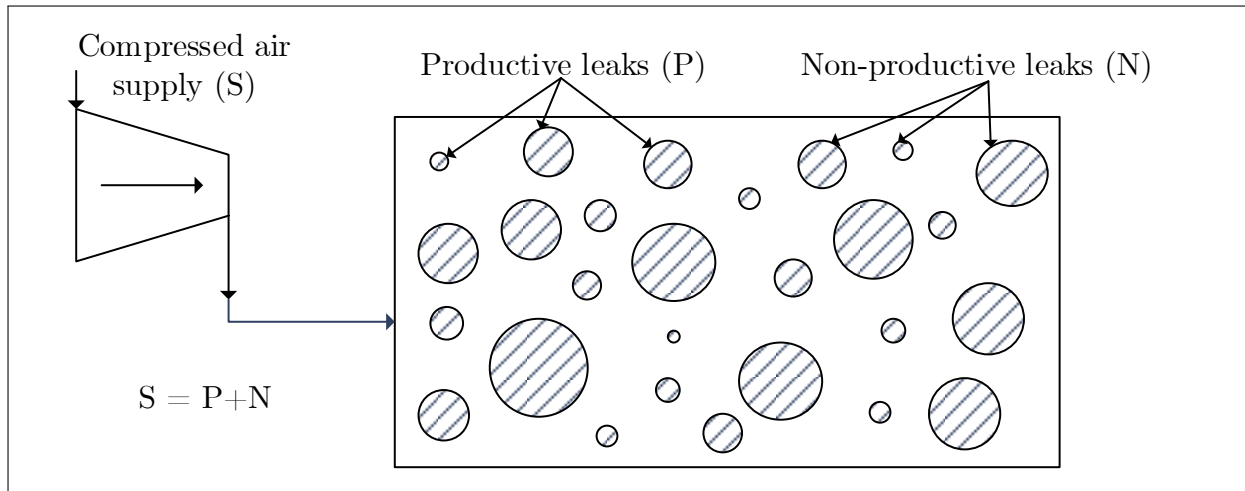

Figure 1.4: Simplified compressed air network model. (adapted from Marais [6])

A calculation methodology was developed to quickly estimate the expected energy-saving impact on the system. Based on this methodology, energy-saving estimations and rules were designed as listed in Table 1.1.

Table 1.1: Summary of energy-saving estimation rules [6]

Intervention	Estimation rule
Reducing compressor delivery pressure	$x\%$ pressure reduction $\propto (1.6 \text{ to } 1.8) \cdot x\%$ power reduction
Reduce control valve pressure	$x\%$ pressure reduction $\propto p \cdot x\%$ power reduction. Where p is the valves' relative flow contribution to the system
Reduction of flow	$x\%$ flow reduction $\propto x\%$ power reduction

There is not a high degree of precision in this approach as specific details regarding the air network are not taken into account. The simplified approach cannot be used to estimate more complex scenarios. The method also does not estimate other potential benefits of interventions such as pressure delivery improvements.

Simplified air network model

Kriel [17] used simulation to estimate the performance of energy projects on mine compressed air systems. The KYPipe GAS software tool was used to develop simulation models for these systems. Kriel simplified the air networks for the simulations to a single compressor that represents the supply processes and an outlet flow to each underground level in the network. The model is shown graphically in Figure 1.5.

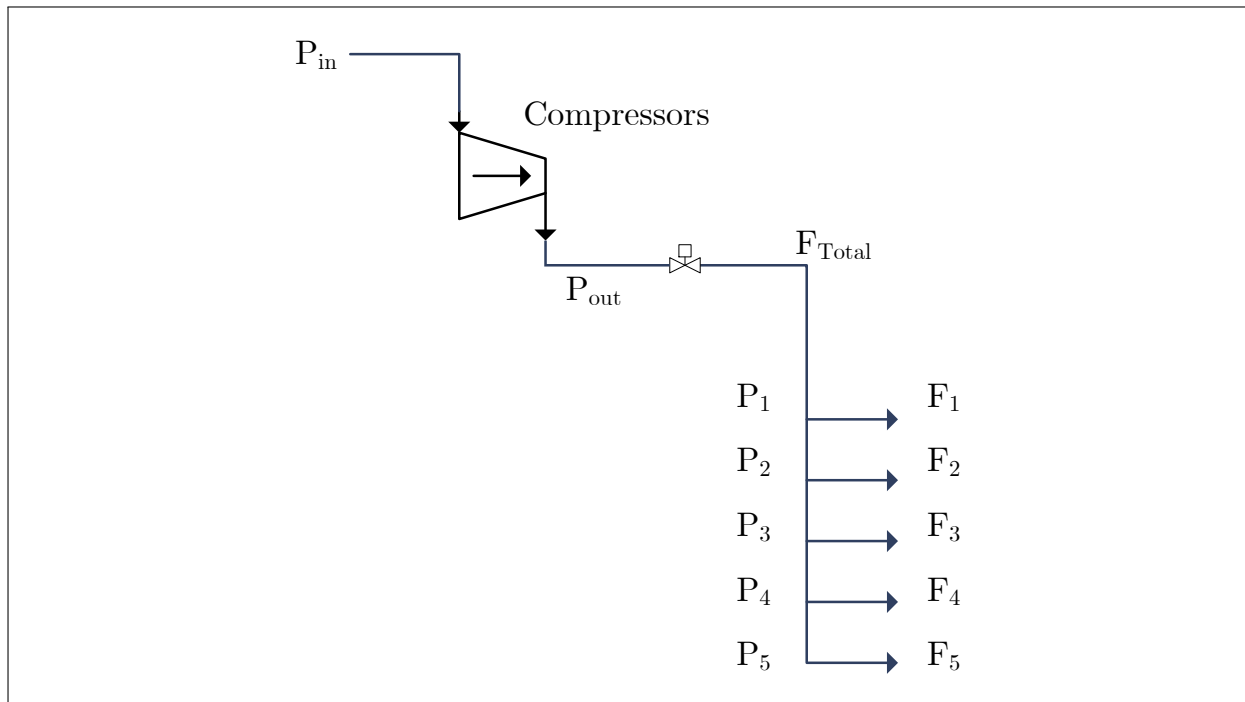

Figure 1.5: Simplified system model (adapted from Kriel [17])

The simulation was performed to quantify the savings from underground network interventions that had been designed to reduce flow to the network. The estimated savings from the simulations varied between 10 and 25% compared to the actual performance of the interventions. Like the “vessel” model discussed previously, the simplified air network model cannot be used to estimate the energy-savings potential of more complex scenarios.

The simulation procedure in this study could be improved by using a more detailed model and a more precise verification method. The method could lead to more accurate predictions of savings.

Planned manual measurements, estimations and new software technologies can be used to develop more detailed compressed air models [18], [19]. Using a structured procedure may allow for the development of more detailed and accurate mine compressed air simulations.

1.5 Problem statement and objectives

1.5.1 Problem statement

Rising expenditure and falling ore grades compel the mining industry to reduce operational costs. Research has shown that the industry can reduce energy costs significantly through interventions in compressed air systems. Unfortunately, manual testing of these interventions is risky and cumbersome.

Computer modelling and simulation of compressed air systems can be used to quantify and prioritise operational interventions with minimal risk. However, integrated simulations have not been used to their full potential in compressed air system studies in the past. With new tools available to develop detailed simulation models, the energy and operational efficiency of mining compressed air systems can be improved, and this may lead to significant energy and cost savings as well as other potential improvements in mining operations.

Thus, a need exists for an integrated compressed air simulation approach to identify energy and operational improvements for mines.

1.5.2 Research objectives

The primary aim of this study was to create energy-savings opportunities through the identification of operational improvements in mining compressed air systems. A simulation process was developed to achieve this goal. The other objectives of this study were the following:

- Develop an integrated approach to develop and implement compressed air simulations
- Use simulations to apply and rank compressed air operation interventions
- Model mining compressed air networks and components accurately
- Develop an approach to verify compressed air simulation models

1.6 Dissertation overview

Chapter 1 – This chapter served as an introduction to the dissertation. It provided the relevant background in mining, compressed air and simulation to establish a suitable problem statement. The objectives of the study were subsequently outlined.

Chapter 2 – Chapter 2 next provides a review of the literature and necessary background relevant to the study. The chapter starts by presenting some background on mining compressed air networks and then conducts a review of compressed air energy interventions. A review

of simulation usage in the mining industry comes next, and finally, an overview is given of simulation usage in mining compressed air systems.

Chapter 3 – Chapter 3 provides a simulation methodology that outlines the processes used to investigate a compressed air system, to develop and calibrate simulation models, and finally to implement simulations and obtain results.

Chapter 4 – Chapter 4 provides validation of the methodology through case study results, based on the results of three case studies. Finally, the impact of large-scale implementation of the simulation methodology is discussed.

Chapter 5 – Chapter 5 concludes the dissertation. The chapter also provides recommendations for further studies on compressed air simulation.

CHAPTER 2

Overview of simulation and compressed air applications

“If I have seen further, it is by standing on the shoulders of giants.” - Isaac Newton

2.1 Introduction

This chapter commences in Section 2.2 by providing relevant background on the operation and subcomponents of compressed air networks. A review that follows in Section 3.2 of the literature regarding compressed air energy interventions summarises previous work to improve the supply and demand efficiency of mining compressed air networks.

The use of simulation in mining systems is reviewed next. Section 2.4 summarises the usage of mathematical estimation and simulations tools in the mining industry and discusses the simulation tools, as well as simulation and verification procedures that were available in the literature.

Finally, simulation usage in compressed air systems is discussed. Section 2.5 summarises the successes and shortfalls in previous compressed air simulation studies.

2.2 Background on mining compressed air networks

2.2.1 Preamble

Compressed air is used extensively in a mine in both surface and underground operations. This section provides background regarding the compressed air networks used in mines. It firstly discusses the components that make up a mining compressed air system, then examines the typical functioning of the system and finally discusses the instrumentation that is typically installed in compressed air networks.

2.2.2 Compressor air network components

Compressors

Compressed air in mining is most commonly supplied by a centrifugal-type dynamic compressor [20], [21]. These machines achieve compression as a result of the centrifugal force from the high-speed rotation of impellers in the air. An electric motor drives the rotating impeller.

Multi-stage impeller compressor designs, as shown in Figure 2.1, are used to obtain higher pressure ratios [20]. The compression process is inefficient. Only about 5 to 10% of the input energy of the process is converted into energy that is used [22].

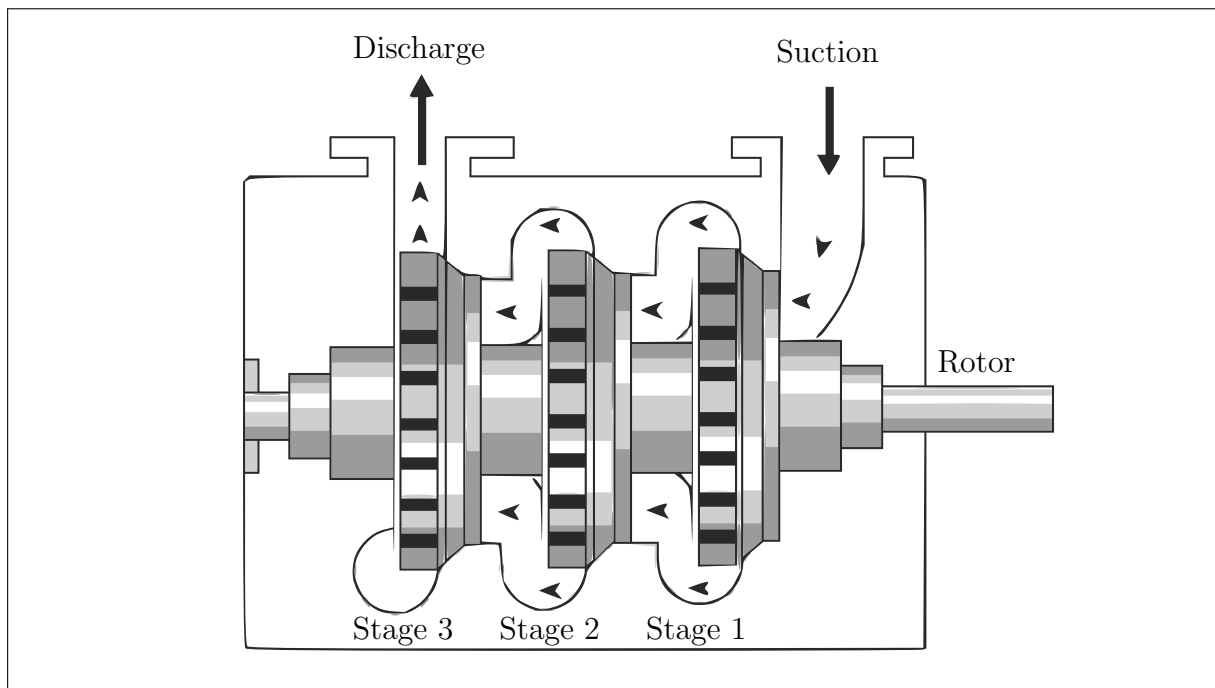

Figure 2.1: Schematic representation of a multi-stage centrifugal compressor¹

Pneumatic rock drills

Drilling is performed mainly in the production areas or stopes of a mine. Drill machines are used to drill holes into the rock face, and once the holes have been drilled, explosives are installed to break up the rock [23]. As discussed in Chapter 1, pneumatic drill machines are not very efficient when compared to other technologies.

Refuge bays

Refuge bays are installed underground in deep-level mines to provide safety to miners in the event of an emergency. Due to safety regulations, most mines will utilise compressed air to deliver fresh air to the chamber [24]. Figure 2.2 shows an example of a compressed air inlet at an underground refuge bay. A muffler is installed at the end of the inlet air pipe to reduce noise.

Altogether 1.42 l/s of air per person at a pressure of between 200 and 300 kilopascal is required to provide oxygen and prevent any poisonous gas entering the refuge [24]. Airflow in the refuge bays is controlled by a manual valve inside the room. The manual valves are often misused by mine workers to cool the bay through decompression of the air.

¹ Abc oil refining, "How centrifugal compressors operate," [Online] <http://abcoilrefining.blogspot.co.za/2012/03/how-centrifugal-compressors-operate.html>, [Accessed 15 August 2017].



Figure 2.2: Example of a compressed air inlet in an underground refuge bay chamber of a mine

Processing plants

Processing plants are constructed near mines. They are used when extracting metal from the ore that is obtained from the mining operation. These plants use compressed air for various systems, processes and equipment.

Processing plants often share a compressed air network with mines to save costs [6]. The plants use relatively small amounts of air compared to mines. However, plant processes have pressure requirements that differ from the rest of the air network. If the plant air supply is not isolated from the shaft's air system, energy optimisation can be complicated [17].

Other compressed air users

Due to its availability underground, compressed air is used for several other applications. These usages include pneumatic loaders or rock shovels, pneumatic cylinders, dam sediment agitation, cooling and ventilation and many other applications. Unfortunately, this vast variety of applications also leads to the misuse of compressed air, which in turn leads to inefficient operation [6].

2.2.3 Operational schedule

On a typical mine, various operations are scheduled for different times of the day. Depending on the activity taking place, many mines will control the pressure to meet the requirements of the tasks [6], [17]. Figure 2.3 shows the schedule and pressure requirement on a typical deep-level mine.

As shown in Figure 2.3, the pressure requirement changes, depending on the activity that is taking place. The drilling shift typically has the highest pressure requirement, whereas the blasting shift requires the lowest. This fluctuating pressure requirement shows scope for optimisation. However, it has been observed that many mines do not optimise their compressed air supply efficiently [7]. Since the schedules and operation philosophies differ between mines, different operational schedules require alternative pressure requirement profiles.

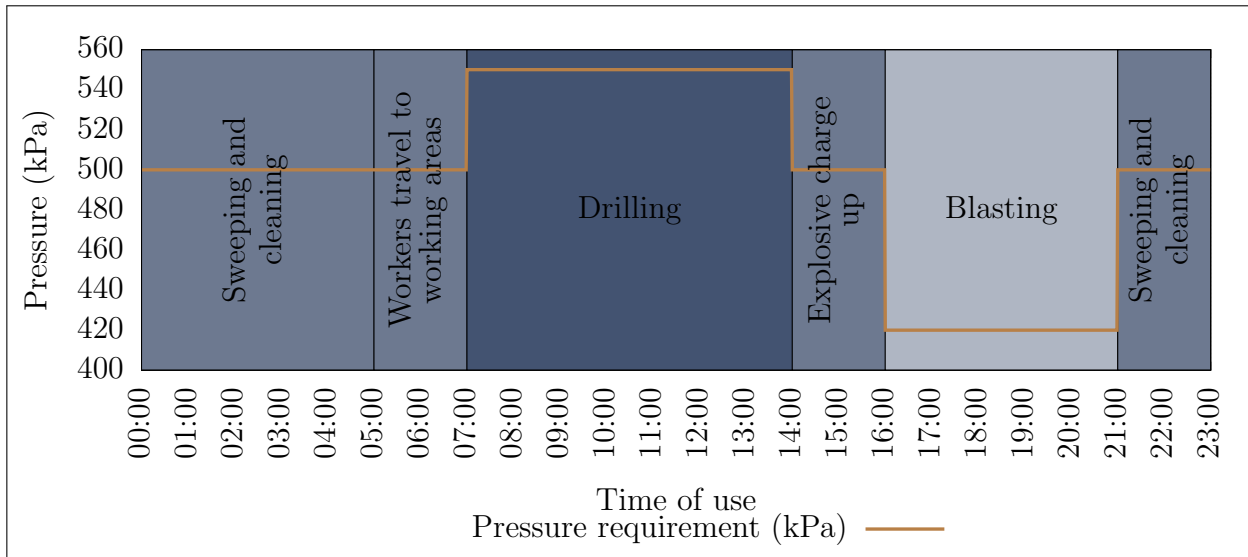

Figure 2.3: The typical operational schedule of a deep-level mine [17]

2.2.4 Instrumentation

For large industrial systems, instrumentation is necessary to monitor performance and equipment conditions throughout the system. In a mining compressed air network, instrumentation is installed to monitor flows, pressures, temperatures and other process parameters. Electrical instrumentation is also installed for sensing currents, power factors, voltages and power. Parameters that are often measured include valves' input/output pressures and flows, valve and guide vane positions and air condition metrics, which are usually measured with instrumentation.

Supervisory Control and Data Acquisition (SCADA) systems are used to monitor and control processes throughout the mine. The instrumentation and SCADA systems are connected on a communication network. This communication between the underground Programmable Logic Controllers (PLCs) and surface SCADA is achieved by using a significant fibre optic network [25]. The SCADA system centralises instrumentation data from PLCs and instrumentation in the mine. It is also used to control machines and instrumentation by transmitting signals over the network.

2.2.5 Summary

This section was devoted to a discussion of various subcomponents of compressed air networks, such as compressors, processing plants, as well as underground air users. The daily process scheduling and the effect on compressed air requirements were also reviewed. Finally, the typical instrumentation found in a mining compressed air system was summarised.

2.3 Review of compressed air energy interventions in industry

2.3.1 Preamble

Compressed air improvement can be achieved through intervention in either the supply or demand processes of a compressed air system [17]. The supply processes are improved by increasing the efficiency of the compressed air supply. Examples of air supply optimisation measures include Dynamic Compressor Selection (DCS), compressor relocation, repairs and maintenance [14].

Due to the size of mining compressed air networks, there is often a larger scope for improvement in air demand. Air usage is improved by optimising consumer usage patterns, reducing leaks and performing other interventions. Air demand optimisations include reducing unnecessary air use, optimising control and reducing system pressures [26].

This section will review compressed air supply and demand interventions that have improved energy or operational efficiency in the mining industry. Based on the literature, successes and shortcomings in previous studies will be discussed and analysed.

2.3.2 Strategies to improve compressed air supply

Optimising compressor control

The number of available compressors, as well as the compressor power ratings differ between compressed air systems. Compressor selection is crucial to ensure that the correct compressors are matched with the requirements of the system [27].

Booyesen [21] found that many mines control compressors by using fixed pressure points that are much higher than required. In one system, compressor controllers were set to target 650 *kPa* to ensure that pressure underground did not fall below 500 *kPa*. Use of high

set-points can lead to excessive, wasteful blow-off in a deep-level mine when the pressure exceeds maximum operating points.

Booyesen [28] furthermore showed that energy savings can be achieved through dynamic pressure set-point control¹ and optimal compressor selection. In a case study, an average power demand reduction of 1.07 MW was achieved, which led to an energy improvement and an estimated cost saving of R3m.

Optimising control of compressors to match the demand of the system can be complicated. Variable Speed Drives (VSDs) and guide vanes are used to control the capacity of the network. More effective power reductions can be achieved through the use of VSD control [29]. However, installing such controllers can be very costly.

Running compressors at part load will reduce the efficiency. Research has shown that electric motors will typically use 60-80% of their rated power when operating at less than 50% load [30].

Reconfiguring compressed air networks

Some old mining compressed air systems have not been adequately maintained and improved. Often they cannot sufficiently supply sufficient air to meet the demand, or air is provided from non-optimal sources. In a study by Bredenkamp [29], reconfiguring of the air network was investigated to improve these systems.

In this study, Bredenkamp investigated the interconnection of compressed air systems of two mining shafts and relocation of a compressor. This strategy led to an average power reduction of 1.7 MW and an estimated annual energy cost saving of R8.9m at the time.

2.3.3 Strategies to reduce compressed air demand

Decreasing the airflow demand is achieved by reducing additional airflow such as leaks, optimising the operating pressure to match the demand², and improving the efficiency of air usage or replacing equipment with non-pneumatic alternatives [14].

¹ Matching the supplied pressure with the specifically required air demand

² Matching the supplied pressure with the required air demand. Optimising the supply is achieved by identifying the minimum required operating pressure for all times of the day as illustrated in Figure 2.3

Leakage detection

Air leaks are a major inefficiency in compressed air systems. Fixing leaks is an effective measure to reduce air demand and improve the efficiency of the system [31]. However, identifying leaks is difficult and time consuming.

Air leaks occur as a result of open pipes, fissures and breaks. Losses depend on the size of the leak and pressure in the network. Figure 2.4 shows the theoretical airflow through a pipe orifice as a function of leakage area and pressure¹. According to Van Tonder [31], the system power consumption increases with the amount of air leakage. Therefore, energy savings can be achieved through either reducing pressure or detecting and fixing leaks.

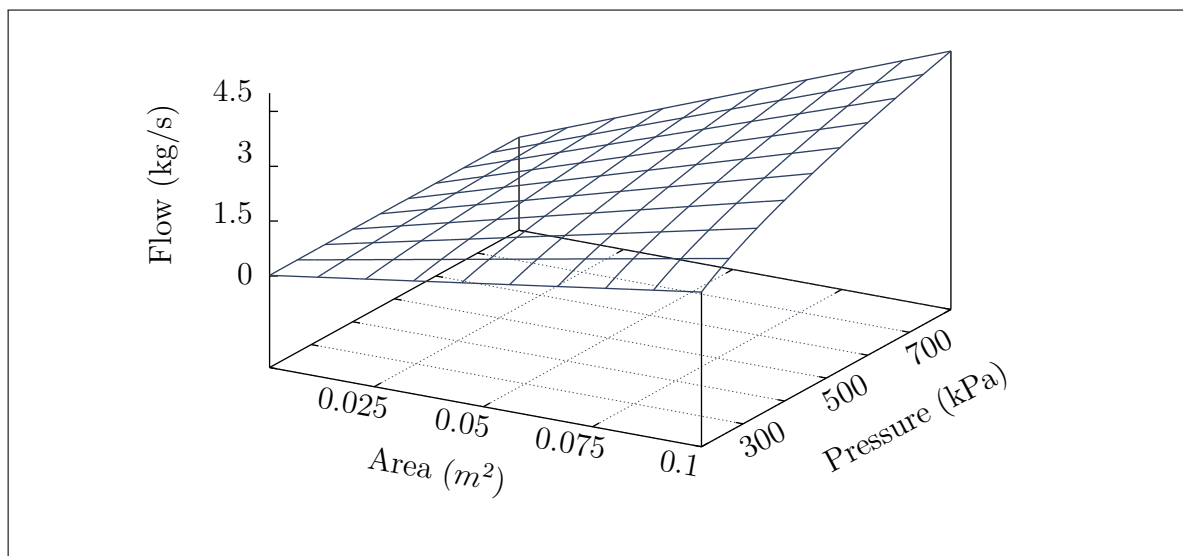

Figure 2.4: The flow due to leakage as a function of inlet pressure and leakage area¹

Although leaks are often difficult to detect through visual methods, many techniques can be employed in industry to detect air leaks. Pascoe [32] and Van Tonder [13] summarise these techniques as follows:

- Audible detection (Walk and report)
- Ultrasonic detection
- Intelligent systems²
- “Pigging”³
- Soap water/visible dyes

¹ efunda, “Orifice Flowmeter Calculator.” [Online] http://www.efunda.com/formulae/fluids/calc_orifice_flowmeter.cfm, [Accessed 18 October 2016]

² Leakage detection by using strategically placed measurement equipment and smart computer systems.

³ The use of a device, “pig”, within the pipe to perform inspections.

These methods are time and resource intensive, and many mines do not actively employ dedicated leakage detection and repair teams. Marais *et al.* [33] investigated how to streamline the leakage detection and repair process to increase energy savings by using a Compressed Air Leakage Documentation System (CALDS). The system was developed to allow centralised mobile leakage reporting. Usage of CALDS in mines resulted in an increased leak detection rate. For instance, one mine reported 24 leaks in a single month. It was noted in the study by Marais that there was difficulty quantifying the actual energy savings of the leakage repairs, due to the co-occurrence of other interventions.

Underground control valves optimisation

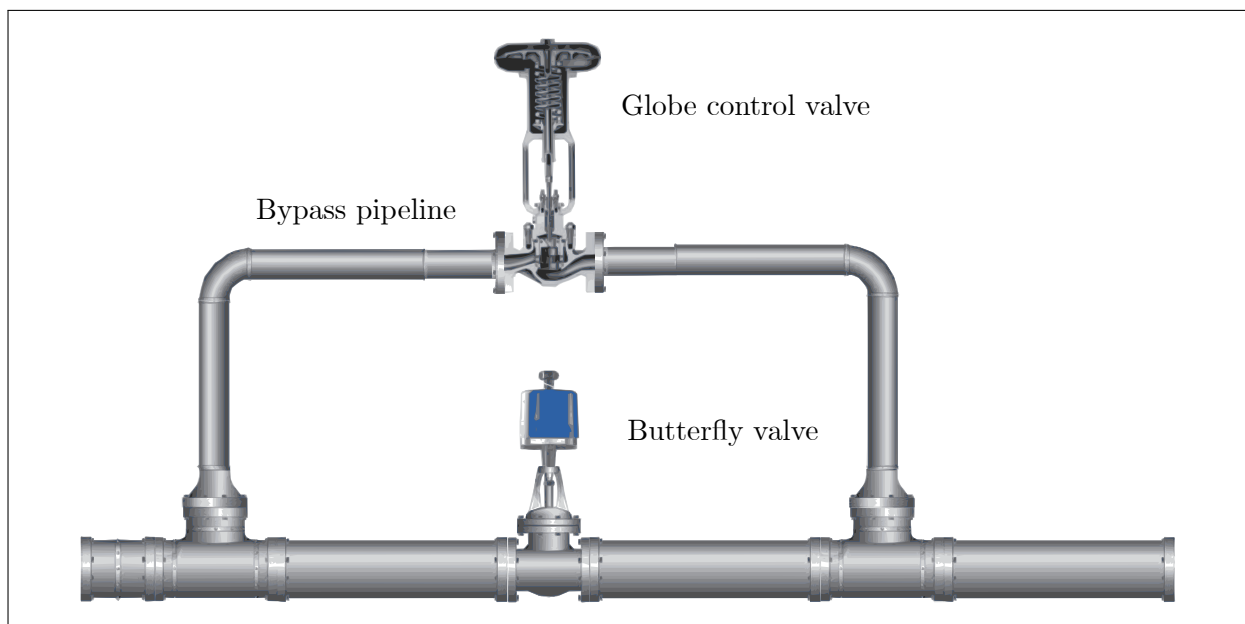

Figure 2.5: Illustration of a control valve [17]

Many mines utilise automated valves, as illustrated in Figure 2.5, at critical locations or on different levels in the compressed air network. These valves control the pressure, thereby restricting airflow from that point in the air network. Restricting airflow reduces losses that result from network inefficiencies and leaks.

Kleingeld and Marais [26] found that optimising valve control on different mining levels can conservatively lead to 20% energy improvement in mines where no control valves are installed. For systems that already have some form of network control, between 10 and 15% of savings can conservatively be achieved.

The literature revealed that the advantages of control valve optimisation bring about a significant saving that can be achieved within a relatively short set-up time. Savings can be achieved incrementally with each control valve installation. Previous studies looked at

simplified estimations of energy improvement that may result from underground control valve optimisation. However, integrated simulation has not yet been used to accurately determine the energy savings as well as shaft pressure improvements that may occur from such optimisations [25],[34], [33], [26],[19].

Improving pneumatic rock drill efficiency

Although pneumatic rock drills constitute the largest air consumers in a mine, the energy conversion of pneumatic drilling is very inefficient. Thus, replacing pneumatic drills with more efficient alternatives such as hydraulic or electric drills would lead to large energy savings [32]. Alternatively improving the efficiency of pneumatic drilling can have a significant energy impact on the system, without causing the cost and safety concerns of alternative drilling technologies.

A study by Bester *et al.* [35] that looked at the effect of compressed air pressure on energy demand, showed that compressed air and energy consumption per tonne of ore produced steadily increased between 2002 and 2013. The shift in energy and air volume per tonne of produced ore over time is illustrated in Figure 2.6.

The increase of air consumption per tonne resulted from reduced air pressure at the mining areas. The pressure reduction caused a drop in the drilling rate, which led to higher air consumption. Pressure measurements as low as 300 *kPa* were recorded in these regions. In 2002, the drilling pressure in the mining section (stopes) was maintained above 500 *kPa* at most mines¹.

¹ H. Heller, 'Compressor Performance Data,' Impala Platinum Mine UTS , 2002 - 2013.

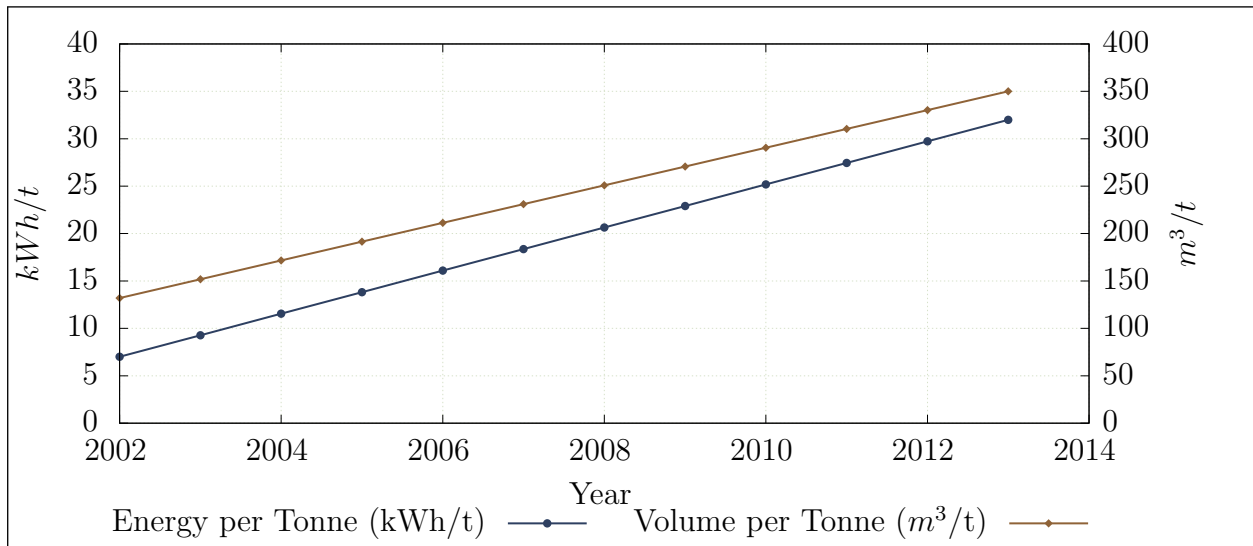

Figure 2.6: The compressed air energy and flow consumed per tonne of ore produced (adapted from Bester *et al.*[35])

Research shows that lowering the pressure reduces the efficiency and drill rate of rock drilling, which leads to higher air consumption. Interventions that reduce systemic air losses or optimise supply can increase the operating pressure. Increased pressure during the drilling shift may however add more value than the energy cost savings that can be achieved at a lower pressure [35].

2.3.4 Summary

The above section reviewed previous studies that achieved energy improvements in compressed air systems. The literature was divided into studies that focus on improving the supply of compressed air and those that optimise the demand for compressed air.

Compressed air supply interventions that were discussed include optimising compressor control and reconfiguring compressor networks. On the demand side, studies that investigated reducing leaks, optimising underground valve control and improving rock drill efficiency were discussed.

2.4 Use of simulations to identify improvements in mining systems

2.4.1 Preamble

The value of simulation in the mining industry has been widely shown through its usage in Demand-Side Management (DSM) initiatives. Simulation and estimation procedures were applied to identify and pre-emptively quantify the effect of energy interventions strategies for the water reticulation, cooling, compressed air and ventilation systems of mines.

The purpose of this section is to summarise and discuss the work that has so far been done concerning the estimation and simulation of mining systems. This section will also discuss simulation development procedures and verification methodologies that were applied in literature.

2.4.2 Estimating energy savings on mining systems

Estimation has been a vital tool to determine the potential energy impact that can be achieved from interventions to a mining system. Before new tools existed that allowed for the quick development of simplified simulation models, estimation techniques were frequently used to determine the feasibility of energy interventions.

The shortcomings of the estimation approaches are that they typically rely on simplified system models. The simplifications lead to high prediction error and they limit the complexity of scenarios and input/output variables.

Snyman [14] used mathematical estimation to determine the expected power savings from initiatives with regard to mining compressed air systems. Due to uncertainty in the estimations, [14] predicted results were provided as a range between conservative and best-case estimates. The actual achieved energy impact would fall between these estimations. Snyman’s model only estimated the average energy impact and could not provide a resultant power profile or other output variables such as pressure.

2.4.3 Benchmark modelling

Cilliers [36] developed “best practice models” using the Corrected Ordinary Least Square (COLS) benchmarking method. These models provide an energy benchmark that can be used to identify the scope for energy improvement in mining systems. An example of a benchmark model for a mining compressed air system is shown in Figure 2.7. The model can be used to estimate optimal energy required as a function of the quantity of ore mined (T) and the depth of the mining shaft (Z). Cilliers furthermore developed benchmark models for mine cooling, water reticulation and ventilation systems.

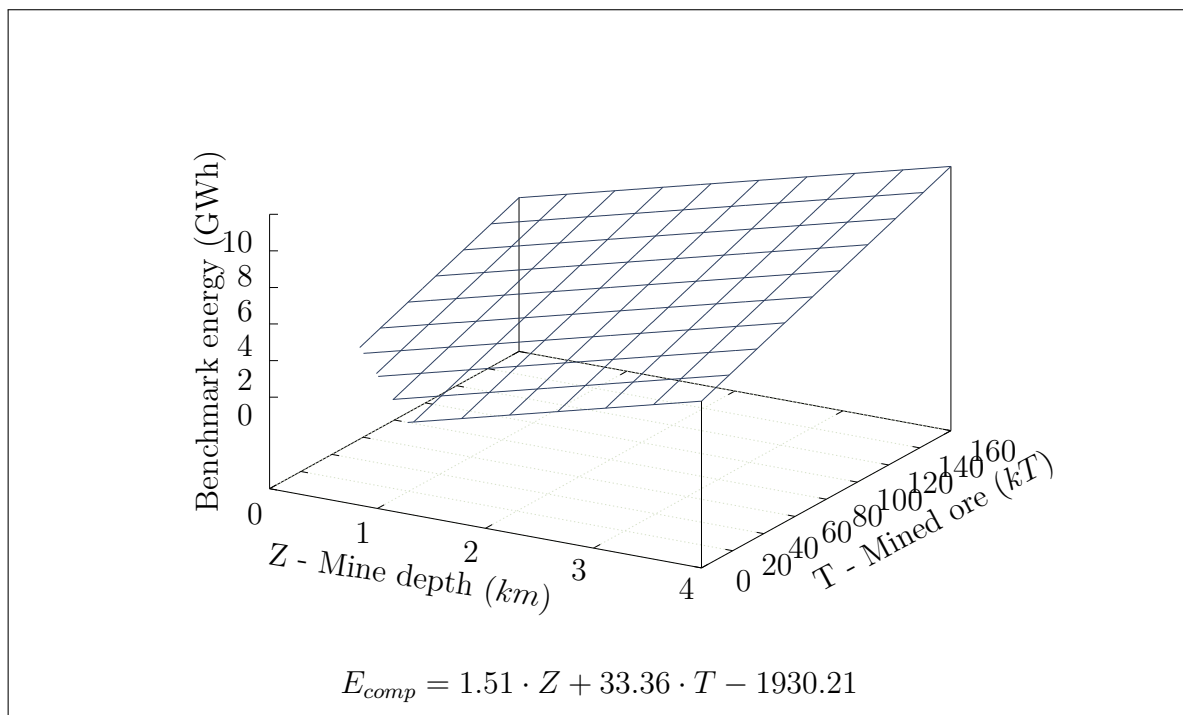

Figure 2.7: Energy benchmark model for a mining compressed air system (adapted from Cilliers [36])

2.4.4 Value of simulation in Demand-Side Management(DSM) of mining projects

Van Niekerk *et al.* [37], [38] investigated the value of simulation models in DSM projects and they developed simulation models for compressed air and water reticulation systems using KYPipes' simulation engine.

The studies by Van Niekerk *et al.* showed that simplified simulations could be used to quickly estimate energy cost benefits of proposed DSM projects. The studies focused solely on the energy-saving potential of DSM projects. A detailed simulation model was not investigated in favour of quick-to-develop or simplified compressed air models.

Simulation has been commonly used in studies as a tool to improve mine cooling. Holman [39] investigated improvements to mine cooling systems that enhance performance and efficiency. In the study, Process Toolbox (PTB) was used to develop and solve simplified simulation models aimed at investigating cooling interventions.

The scenario that Holman simulated showed a potential average power reduction of 136 kW which would lead to an annual energy cost saving of R0.55m. The study could be improved by increasing the accuracy of the simulation. A power error of as high as 31% was observed between the simulation and actual for some time periods.

Simulation has had great value in improving and optimising mining compressed air systems. A detailed review of compressed air simulation applications is discussed in Section 2.5.

2.4.5 Simulation procedure

A structured simulation procedure is required to achieve the objectives of the study. Previous studies available in the literature focused on how simulation software tools work, rather than on the simulation procedure that was followed [40].

Bouwer [41] developed a software tool that he used to investigate extensive thermal and energy systems. He followed the steps below to implement simulations:

- Create a detailed schematic of the system
- Obtain data from installed instrumentation
- Perform manual measurements where necessary
- Gather data for a typical operational period

- Convert data into useful formats
- Set up the simulation model
- Calibrate the model until simulated outputs match measured data

Bouwer’s simulation procedure provides a good guideline for mining system simulation. The procedure could be simplified by merging steps. For example, steps 1 to 4 could be merged into a single step, namely “Gather system data and information”.

2.4.6 Periodic/repeated simulation procedure

The concept of a periodic or repeated simulation involves the execution of a simulation multiple times or on a recurring schedule while altering input parameters. Hollander and Lui [42] used repeated simulations to estimate travel time distributions for traffic networks. They also developed the following methodology for the repeated simulations:

- Gather input parameters
- Run simulations
- Read simulation outputs
- Repeat for desired iterations

Within the mining context, Snyman [14] used repeated estimation to determine an upper and lower bound for the expected result. Another example from industry is real-time simulation or estimation systems.

Van Heerden *et al.* [43] developed a dynamic control system for a mine compressed air network in which the controller utilised repeated simulation to estimate unmeasured and future parameters of the network. The estimated results were used to optimise the compressor control.

2.4.7 Simulation software tools

Available tools

A software tool is required to create and execute (or solve) the compressed air simulations. The available literature presented a variety of software tools that have been used to simulate industrial systems. A suitable software system for this study must be capable of producing accurate models of complex compressed air networks. The system should be able to solve transient compressed air simulation scenarios with dynamic data and control inputs.

The development of system models should furthermore not be excessively time consuming and the software tools should be able to handle missing data inputs and information that are common in mining systems. These were shortfalls of simulation tools noted by Van Tonder [44] and Marais [40].

The following simulation tools that may meet the criteria were identified:

- Process Toolbox (PTB)¹
- Flownex²
- KYPipe GAS³
- Realtime Energy Management System (REMS)⁴

Flownex

Flownex is a thermal-fluid software system that provides a node structure to develop system simulation. Flownex might be a suitable software technology for use in this dissertation, however Maré [40] considered the energy management capabilities of the system to be limited.

REMS

REMS was designed as an energy management system and was installed in mines as an energy-saving control measure. Whilst the system is used to optimise compressed air supply through various measures and provides additional control tools such as DCS [44],[43],[65], the simulation capabilities of the system are limited to steady-state, one-dimensional, isothermal flow simulation [38]. The technology would therefore not be suitable for this study.

KYPipe

As with REMS, KYPipe provides limited, steady-state simulation capabilities [38]. The software solution was therefore not considered suitable for the purposes of this study.

PTB

PTB is a transient system simulation and optimisation tool, and the software was designed for building thermal hydraulic systems. In a recent study, Maré stated that PTB was designed for ease of use and could be applied to mining systems [40].

¹ ETA Operations in-house software

² <https://www.flownex.com/>

³ <http://kypipe.com/gas/>

⁴ ETA Operations in-house software

PTB was therefore used for the current study. Whilst the software system is still under development, the basic functionality was suitable for this study and is specifically suited to energy analysis. The software design allowed simpler and speedier development of system models, because many components (such as compressor mathematical models) have already been pre-built [40]. PTB provided a simple graphical user interface (see Figure 2.8) to develop system models by dragging and dropping components intuitively.

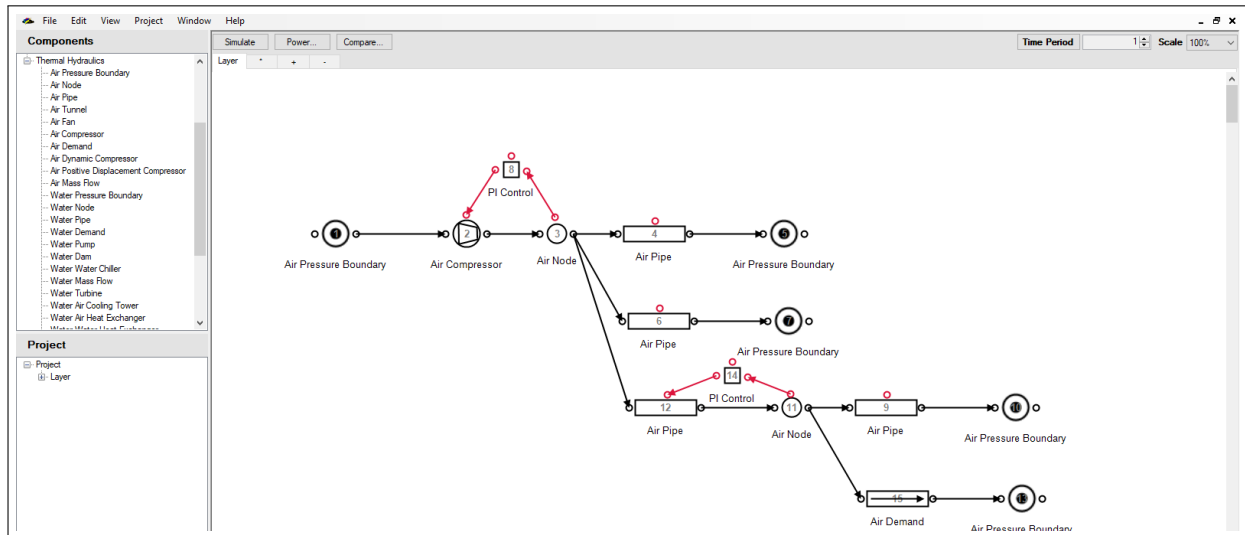

Figure 2.8: The graphical interface of the PTB simulation tool

PTB system models consist of combinations of nodes and pipes (see an example of a model schematic in Figure 2.8). Other component models such as compressors, variable flow demands and controllers are available in the component library. A methodology for the development of compressed air system models in PTB is explained in detail in Chapter 3.

2.4.8 Simulation model verification strategies

Due to a lack of instrumentation, measurement inaccuracies and the sheer scale of mining systems, it is impossible for a simulation model to match the actual system's operation perfectly. Methods of verifying simulation precision were investigated in the available literature, and the verification techniques identified were the Mean Residual Difference, Mean Absolute Error, the coefficient of determination or correlation and Mean Squared Error.

Mean residual difference (MRD) method

The mean difference method looks at the average of the actual and simulated time series. Relative error is then calculated using Equation (2.1). The simulation percentage error from the physical system is subsequently calculated by dividing the error by the actual data points as is shown in Equation (2.2).

$$\bar{R} = \left| \frac{1}{N} \sum_{n=1}^N (A_n - S_n) \right| \quad (2.1)$$

The equation is rewritten to obtain a relative error percentage:

$$Err_{\%} = \left| \frac{1}{N} \sum_{n=1}^N \left(\frac{A_n - S_n}{A_n} \right) \right| \times 100\% \quad (2.2)$$

Where:

- A Actual system time series
- S Simulation time series
- n Data point
- N Number of data points in simulation period

A major disadvantage of this method is that for transient simulation, the positive and negative errors for individual points can cancel out. This leads to a smaller than expected resultant error that cannot guide the reader to any conclusive statements regarding the accuracy of the model [45]. If used alone, this strategy is not recommended for verifying transient simulations.

Yu-jie Xu *et al.* [46] developed a steady-state simulation of an absorption chiller. In the study, mean residual difference was utilised as a measure of the steady-state error for an absorber model. The accepted margin of accuracy in the study was a relative steady-state error of 5%.

Mean absolute error (MAE) method

The Mean Absolute Error (MAE) verification method follows a similar calculation as the average (mean) residual difference method. However, as shown in Equation (2.4), the error is calculated individually for each point in the series. The average of the individual errors is the resultant error, Equation (2.3). The relative error percentage is obtained by dividing each error by the actual value at that time step, as shown in Equation (2.4).

$$MAE = \frac{1}{N} \sum_{n=1}^N |A_n - S_n| \quad (2.3)$$

The equation is rewritten to obtain a relative error percentage:

$$Err_{\%} = \frac{1}{N} \sum_{n=1}^N \left| \frac{A_n - S_n}{A_n} \right| \times 100\% \quad (2.4)$$

Where:

- A Actual system time series
- S Simulation time series
- n Data point
- N Number of data points in simulation period

Coefficient of determination

The coefficient of correlation is the measure of how accurately a data series (x) can be represented in a linear relationship with data series (y), i.e. $y = mx + c$. The value of the coefficient ranges between -1 and 1 where a value of 1 indicates a perfect linear relationship between the series and a value of -1 represents a perfect negative linear relationship. A value of 0 indicates that there is no connection between the data series. The correlation coefficient can be calculated using Equation (II.3) [45].

$$r = \frac{\sum_{n=1}^N (A_n - \bar{A})(S_n - \bar{S})}{\sqrt{\sum_{n=1}^N (A_n - \bar{A})^2 \cdot \sum_{n=1}^N (S_n - \bar{S})^2}} \quad (2.5)$$

Where

- A Actual system time series
- S Simulation time series
- n Data point
- N Number of data points in simulation period

The coefficient of determination or R-Squared value can be calculated by squaring the correlation coefficient (r).

Kurnia *et al.* [47], [48] developed a simulation for a novel underground mining ventilation system. They selected the mathematical model with the highest precision when compared with historical data points. The chosen model had an R-Squared value of 0.96 and a relative error of 30% , using the mean absolute error method.

Mean squared error

In statistics, the Mean Squared Error (MSE) is the average of the square of the error between the actual and estimated value and Root Mean Square Error (RMSE) is the square root of the Mean Squared Error. The value is always positive. A smaller value relates to a more accurate model¹.

$$MSE = \frac{1}{N} \sum_{n=1}^N (A_n - S_n)^2 \quad (2.6)$$

$$RMSE = \sqrt{MSE} \quad (2.7)$$

Where:

- A Actual system time series
- S Simulation time series
- n Data point
- N Number of data points in simulation period

Other methods

Many alternative methods or variations of the methods discussed are available to verify transient simulations. As an example, Arndt [49] considered the percentage of relative errors under certain limits, as well as a maximum relative error. His method is an improvement compared to the residual difference in ensuring transient simulation accuracy.

Sarin *et al.* [45] compared many methods. Some of these methods that have not been discussed in this study include:

- Vector Norms
- Sprague and Geer's Metric [50], [51]
- Russells Error Measure [52], [53]
- Normalised Integral Squared Error
- Dynamic Time Warping (DTW)

The calculations used in the above methods are relatively complex. However, they provide additional measures such as phase, magnitude and slope errors. These metrics could add value in verifying simulations.

¹ University of Kentucky Department of Mathematics, "Estimators, Mean Squared Error, and Consistency," [Online] <http://www.ms.uky.edu/~mai/sta321/mse.pdf>, [Accessed 3 March 2017].

Comparing verification methods

The difference between the strategies is best shown using an example. Figure 2.9 shows the output and actual power of a simulation of a mining system for a 24-hour duration. In the study by Maré [40], Mean Residual Difference (MRD) (Equation (2.2)), was used to determine the accuracy of a simulation model.

With MRD, positive and negative differences between the simulated and actual profiles were cancelled out and the averages of the two power profiles were very similar. The residual difference relative error was therefore calculated as 1.17%. However, using the relative MAE (Equation (2.4)) and applying it to the same data series resulted in a relative error of 15.2%. There is a significant 14% difference between the two measures.

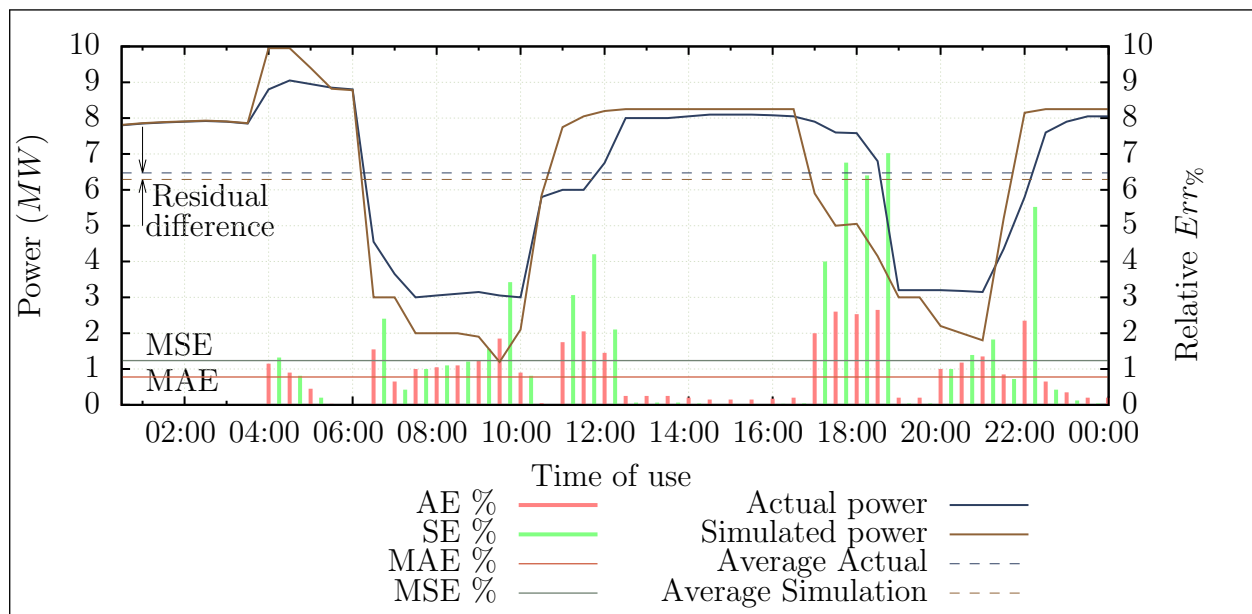

Figure 2.9: Example of simulation error calculations (data adapted from Maré [40])

The results of other verification methods applied in the example are provided in Table 2.1. From the table, it is clear that the accuracy of the simulation model is not as high as when it was interpreted using the residual difference alone.

Table 2.1: Results of the comparison of verification methods

Verification method	Result	$Err\%$
Residual difference	0.06 MW difference	1.17%
MAE	0.778 MW error	15.2%
MSE	1.236	-
Coefficient of determination	$r^2 = 0.857$	-

Willmott [54] studied the advantages of using the mean absolute error (MAE) rather than the RMSE method in assessing model accuracy. In his study, Willmott concluded that measures of average error, for example MSE and RMSE, are functions of MAE. Based on the analysis, MAE was described as the most natural and unambiguous measure of average error magnitude.

Verification usage in previous simulation studies

Previous studies verified simulation accuracy by means of different methods and varying degrees of precision. Table 2.2 summarises these approaches.

Table 2.2: Simulation verification methods implemented in previous studies.

Study	Source	Year	Verification method	Accepted margin
Arndt [49]	Local	2000	Mean and maximum absolute % error	% of time where $Err_{\%} < 10\%$ and $Err_{\%} < 5\%$
Bouwer [41]	Local	2004	Mean residual % difference	$Err_{\%} < 10\%$
Marais [6]	Local	2012	Mean residual % difference	Not specified
Van Niekerk [38]	Local	2012	Mean residual % difference	$Err_{\%} < 10\%$
Bredenkamp [29]	Local	2013	Mean residual % difference	$Err_{\%} < 10\%$
Holman [39]	Local	2014	Mean residual % difference	Not specified
Kriel [6]	Local	2014	Mean residual % difference	$Err_{\%} < 10\%$
VanTonder [44]	Local	2014	Mean residual % difference	$Err_{\%} < 3\%$
Kurnia <i>et al.</i> [47], [48]	International	2014	Coefficient of determination Mean absolute error	$r^2 > 0.95$ $Err_{\%} < 30\%$
Dominic [55]	International	2014	Mean squared error	$< 1.7e^{-3}$
Du Plessis <i>et al.</i> [56]	Local	2015	Mean residual % difference	$Err_{\%} < 7\%$
Pascoe [32]	Local	2016	Mean residual % difference	$Err_{\%} < 5\%$
Peach [57]	Local	2016	Mean residual % difference	Not specified
Maré [40]	Local	2016	Mean residual % difference	$Err_{\%} < 5\%$
Yu-jie-Xu <i>et al.</i> [46]	International	2016	Mean residual % difference	$Err_{\%} < 5\%$

According to Table 2.2, the majority of local studies utilised mean residual difference to determine simulation accuracy. However, literature has shown this is not a valid method for transient simulation verification. International studies used correlation, MAE and MSE for verification. The accepted accuracy margin ranged from a relative error of 3% up to 30%, and the majority of studies used either 5% or 10% as the relative error cut-off. It was not

clearly indicated why local studies did not do the same.

2.4.9 Summary

In this section, we reviewed the use of simulation and estimation techniques to identify improvements in the mining industry. Estimation and benchmark procedures in literature were discussed first, followed by a review of compressed air systems.

Simulation procedures found in the relevant literature were also examined and various simulation software tools used in industry were subsequently compared. Finally, the researcher performed both an analysis and a comparison of simulation model verification procedures.

2.5 Review of the use of simulation in compressed air optimisation

2.5.1 Preamble

This section reviews the literature that describes how simulation can be used to optimise compressed air systems. Shortcomings identified from the literature and that can be improved upon in this study are also addressed. The studies that were reviewed in this section are summarised in Table 2.3.

Table 2.3: Summary of reviewed compressed air simulation studies

Author	Year	Software	Study
Mousavi <i>et al.</i> [58]	2014	Airmaster AirSim	Compressor energy modelling
Zahlan and Asfour [59]	2015	MATLAB	Determining the optimal compressor location
Bredenkamp [29]	2013	KYPipe	Compressor relocation
Pascoe [32]	2016	PTB	Optimised surface valve control Exchanging compressors
Maré <i>et al.</i> [19]	2017	PTB	Various compressor and air network optimisations

2.5.2 Compressor energy modelling

Industrial compressed air systems have significant energy requirements. The system composition can vary widely between air networks, depending on the specific air requirement and control measures of the network. Therefore, modelling the energy consumption of a specific system can provide value in determining the performance of an air network and the scope for optimisations.

In their study, Mousavi *et al.* [58] provide an overview of techniques to model and optimise the energy consumption of a compressor system. They developed a state-based simulation model that could be used for both fixed and variable drive compressors. Mousavi *et al.* subsequently implemented the model in a manufacturing plant.

They used historical data for the system to develop characteristic compressor models and a flow demand profile, and used the system model to predict the energy consumption of the plant in a variety of network control scenarios. Their study (Mousavi *et al.*) considered the following control optimisations:

- Compressor priority determination
- Base-load compressor determination

The study focused on optimisations in the manufacturing industry only and it did not consider improvements in the pressure, flow or temperature process parameters. Mousavi *et al.* did not develop an integrated simulation approach. A simulation approach that integrates and models the compressed air system with manufacturing processes may, therefore, add value to the study.

2.5.3 Determining the optimal compressor location

Determining the optimal location for a compressor can improve the efficiency of an air network, and this improvement can lead to significant energy cost savings. Zahlan and Asfour [59] investigated the use of simulation to solve the problem of optimal location of a compressor in the manufacturing industry.

To determine the optimal location of a compressor, Zahlan and Asfour divided the manufacturing facility into a matrix of rectilinear zones. A mathematical model was developed in MATLAB to determine the energy consumption of the compressors when located in each zone.

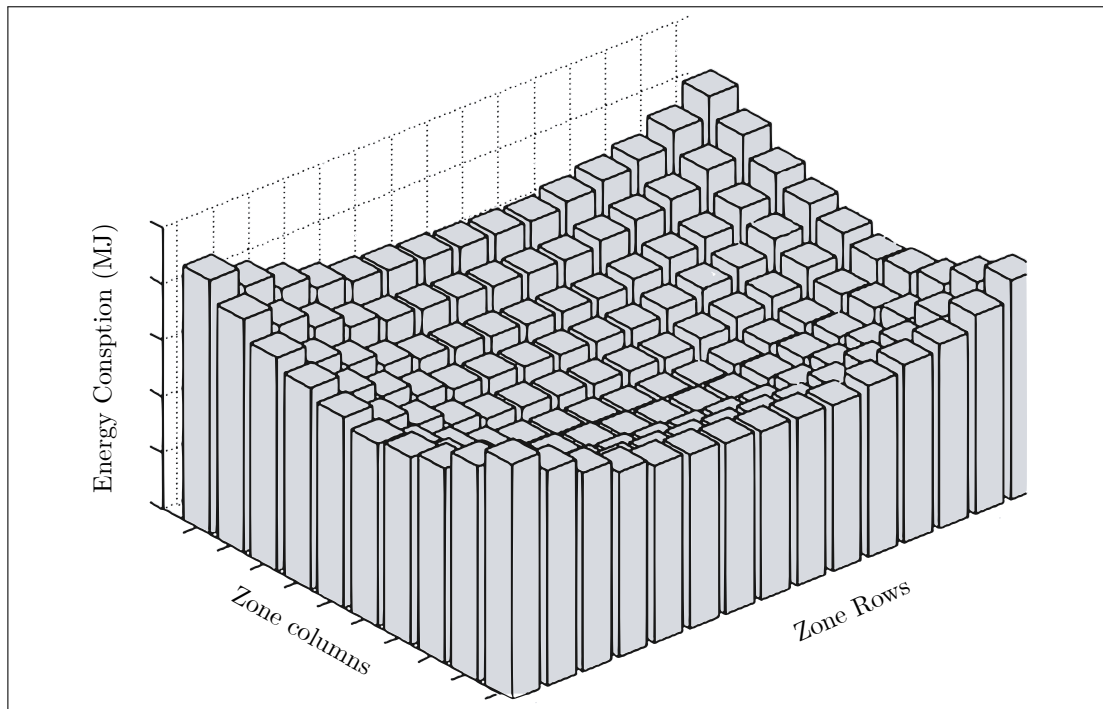

Figure 2.10: Resultant energy consumption matrix (adapted from Zahlan and Asfour [59])

User preference was taken into account by determining a parameter of the extent of the user preference for each zone in the matrix. The user preference parameter and energy savings per zone were weighted and summed to arrive at the optimal zone. Figure 2.10 shows the simulated energy consumption for the compressors at each zone location. The energy consumption was combined with a user preference matrix to determine the optimum compressor location.

The approach towards determining the optimum compressor location would not be suitable for mining compressed air system. Mining air networks extend for kilometres in the x, y and z planes. Zahlan and Asfour [59] greatly simplified the compressed air network processes to easily formulate the mathematical model. This approach would not be suitable for larger and more complex mining air networks.

2.5.4 Compressor relocation in a mining system

Bredenkamp [29] utilised simulation models to test compressor relocation scenarios in order to improve the efficiency of a mining air network. The simulation model developed by Bredenkamp (using KYpipe) took into account the location, the supply capacity of each compressor, as well as the surface pipe distances. The model, as visualised in Figure 2.11, simplified the air demand of the network to a single outlet flow per shaft.

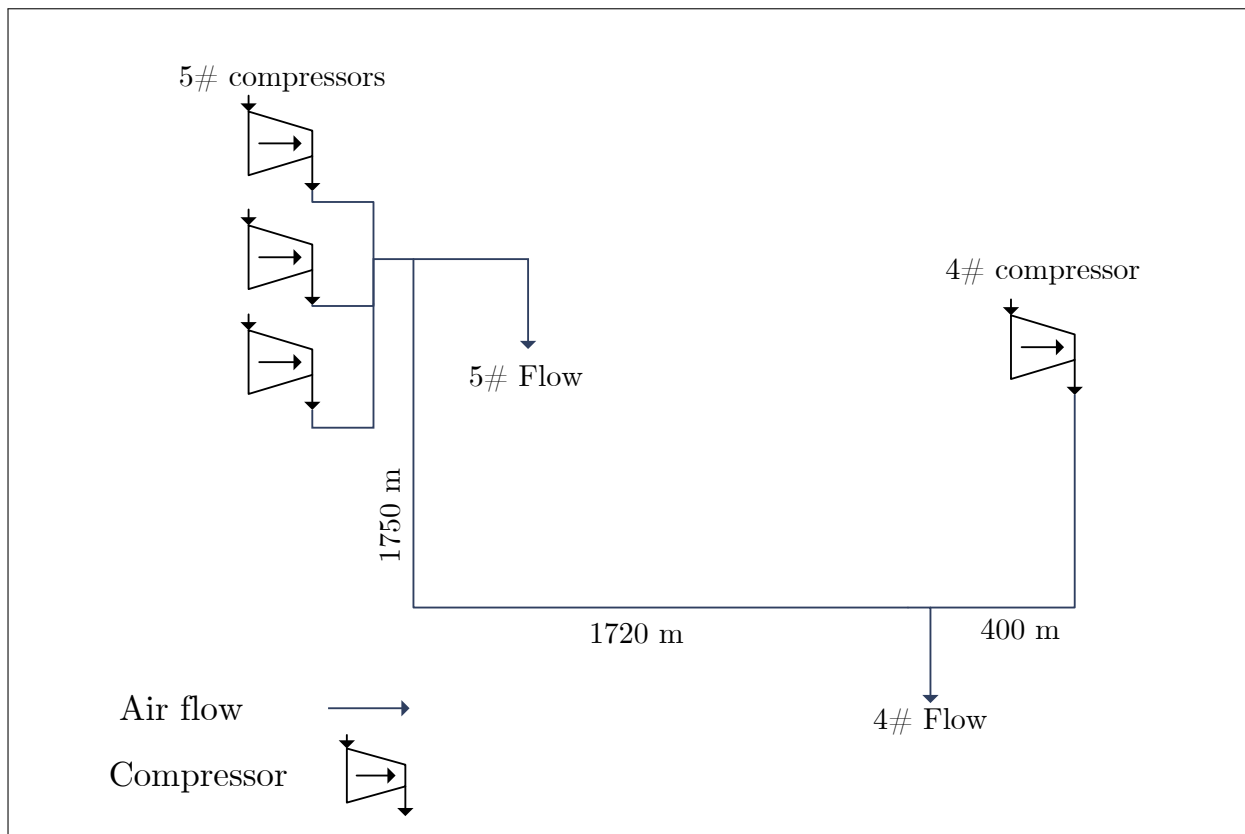

Figure 2.11: Compressor relocation simulation model (adapted from Bredenkamp [29])

The result of Bredenkamp's simulation showed a potential energy cost saving for the mine of R170m over 13 years. The cost savings implied that it was feasible to purchase a new compressor at an estimated cost of R15m. Additional surface delivery improvements were also identified from the simulation.

Bredenkamp did not follow a clear simulation methodology for developing the compressed air simulation, but utilised the residual difference to calibrate and verify the model parameters. Thus, it can be deduced that the simulation precision could be improved by following a detailed methodology.

Increasing the detail of the demand components may provide valuable results and show more particular effects that result from the simulated scenarios, such as the specific delivery pressures at mining level as a result of the intervention. In addition, more scenarios or scenario combinations could be simulated, with potentially greater savings.

2.5.5 Compressed air ring

Pascoe [32] developed a simulation model for a compressed air ring. The purpose of the simulation was to identify the benefits of reducing pressure during the blasting shift period through surface valve control. In a second study, Pascoe used simulation to investigate the

control benefits of exchanging a large compressor with two smaller compressors.

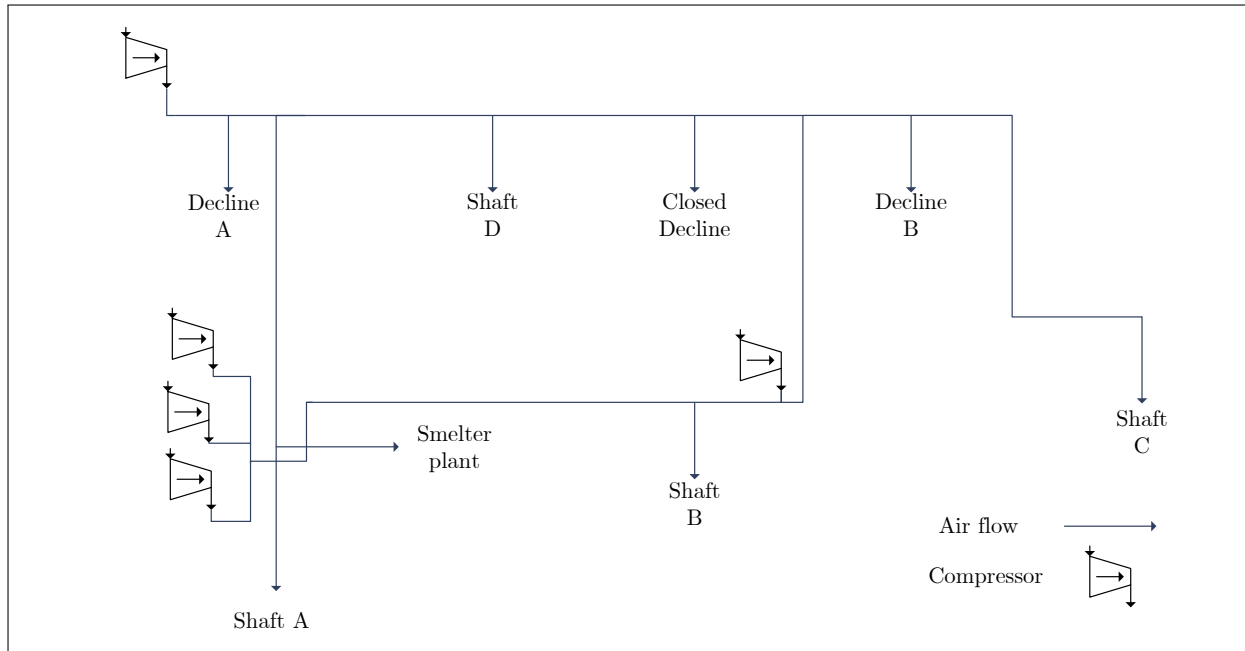

Figure 2.12: Simplified compressed air ring model (adapted from Pascoe [32])

The model required complex supply-side detail, including the modelling of the individual compressor, locations of compressors and pipe lengths and control valves. The demand aspect of the system was simplified to a single flow per shaft, decline or processing plant. A schematic representation of the simulation model is shown in Figure 2.12.

The methodology for simulation development used by Pascoe can be improved. For example, as was the case with Bredenkamp [29], Pascoe utilised the residual difference to calibrate and verify the transient simulation output variables. The simulation precision could therefore be improved by using a suitable transient error calculation method as discussed in Section 2.4.8. The researcher simplified the air demand models to a single flow per shaft. Integrating the model with the demand process within the shafts could therefore add value.

2.5.6 Mine complex

Maré *et al.* [19] developed a compressed air simulation for a mining complex. In their study, they simulated and prioritised several scenarios with the goal of reducing energy and other operational costs.

Maré *et al.* accurately modelled the individual compressors at each shaft in the mining complex. Since the detailed flow consumption at individual mining levels was found to be inaccurate, the process boundaries for the model were selected to include only the deep level consumption at the shaft. A process schema for the simulation mode is shown in Figure 2.13.

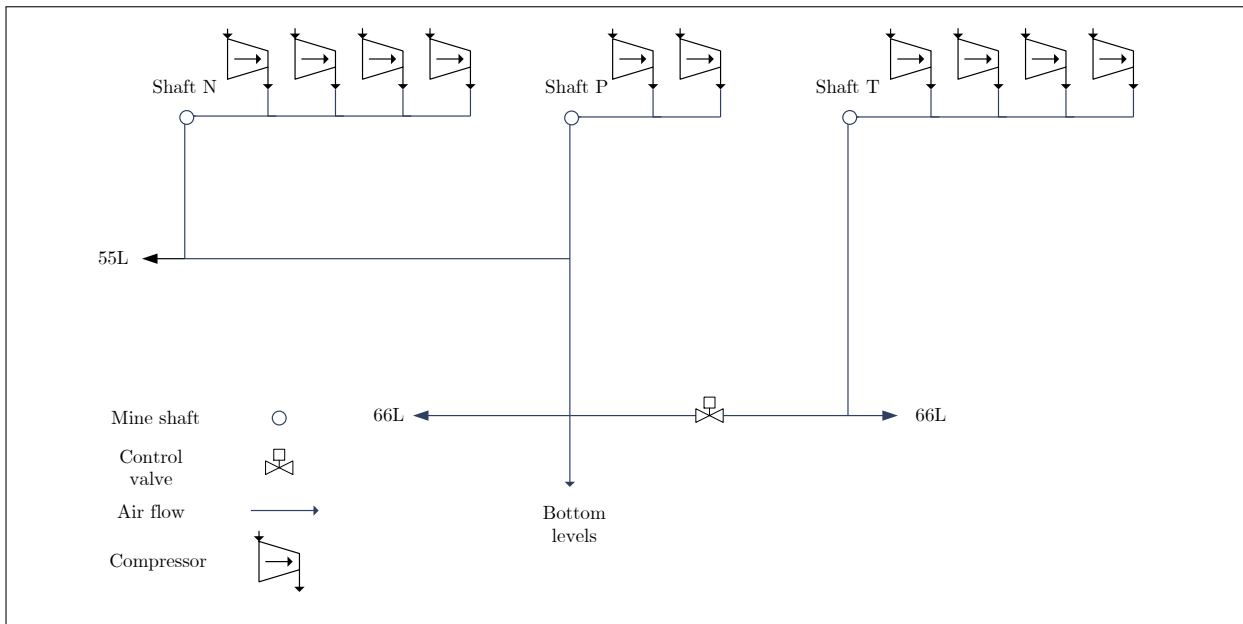

Figure 2.13: Simulation model for a complex air network (adapted from Maré *et al.* [19])

Eight scenarios were simulated using the model. The combined results showed that there was a potential energy saving of R1.5m, as well as an additional pressure improvement of 51 *kPa*. The infrastructure and resource costs were estimated to prioritise the interventions and so to ensure the greatest financial benefit to the mines.

Maré and his co-authors used the residual difference to calibrate and verify the accuracy of the transient simulations. Therefore, the actual estimation error was greater than what is shown in their study. Through on-site inspections and strategic measurements, the detail of the simulation model could be improved. This could allow for more accurate simulations and more simulation scenarios.

2.5.7 Summary

Previous work in compressed air simulation was summarised and reviewed in this section. From the review of the literature, shortcomings and areas for improvement were identified. Five compressed air simulation studies were reviewed and the findings are next summarised in Table 2.4. In general, increasing the detail of system models should improve simulation accuracy and allow further simulation scenarios.

Table 2.4: Summary of shortcomings in previous compressed air simulation studies

Study	Shortcoming
Compressor energy modelling [58]	Focused only on manufacturing plants. Ignored air demand improvements.
Determining the optimal compressor location [59]	Method cannot be applied to larger and more complex 3D mining systems.
Compressor relocation [29]	System was over-simplified. Only considered energy improvements.
Optimised surface valve control Exchanging compressors [32]	Air demand was simplified to a single flow per shaft.
Various compressor and air network optimisations [19]	Model calibration technique and accuracy can be improved.

2.6 Conclusion

In Chapter 2, a comprehensive study of the relevant literature was performed. First of all, some background information on compressed air networks was provided. This included background regarding various compressed air sub-components, the operational schedules and their effect on compressed air requirements, and the typical instrumentation found in a mining compressed air system.

Next a review was conducted of previously achieved energy interventions and improvements in the compressed air systems. The literature was divided into studies that focused on improving the supply of compressed air and those that optimised the compressed air demand.

The use of simulation and estimation in the mining industry was subsequently reviewed. Estimation and benchmark procedures in literature were discussed first, followed by a review of simulation usage in mining DSM. Simulation procedures from the literature were studied and various simulation software tools used in industry were compared. Verification procedures were also analysed and compared.

Finally, the use of simulation to optimise compressed air systems was reviewed. Five relevant studies were examined. The shortcomings, successes and potential improvements of previous compressed air simulation studies were discussed and summarised.

CHAPTER 3

Developing a simulation methodology

“Great Design is iteration of good design.” - Dr M. Cobanli

3.1 Introduction

This chapter provides details about the development and implementation methodology of simulations to optimise compressed air systems in the mining industry. The method that was developed uses insights gathered from the literature that had been reviewed (see Chapter 2). The PTB simulation software was used for this study. However, the methodology can be adapted for an equivalent alternative tool.

Implementation of a simulation model is divided into three steps as shown in the flow diagram in Figure 3.1. Firstly, the specific air network is investigated. The data acquired from the system survey is then utilised to develop and verify a simulation model. In the final step, scenarios are tested using simulations. The results are then quantified and prioritised. After the process has been reviewed, a simulation report is produced and given to the responsible mine personnel. Each step will be discussed in more detail in the section that follows.

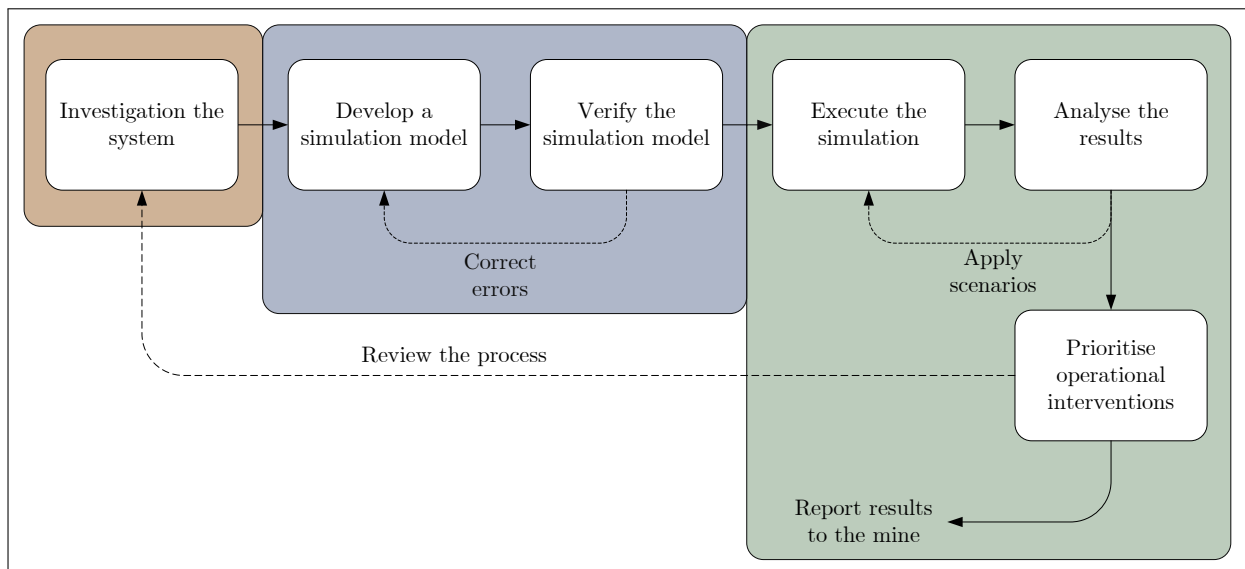

Figure 3.1: Flow diagram of the methodology for this study

3.2 Investigate the system

3.2.1 Preamble

Developing a detailed simulation model of a compressed air network requires thorough comprehension of the inner workings of the system. This section will discuss the investigations needed to obtain the required understanding.

3.2.2 Acquire data

The first step in investigating the system is to acquire the data and understanding that will be required to model the functioning of a compressed air system. Such a system survey will need access to resources such as data storage systems and instrumentation, and communication with relevant engineers and personnel.

Comprehensive and up-to-date process layouts illustrate a compressed air network's unique set-up, scale and the location of instrumentation. More detailed layouts can provide per-level air consumption breakdowns of the network, refuge bays areas, mining cross-sections and identified inefficiencies. The layouts are vital to understand the system process and identify what data parameters will be required for the simulation model.

A baseline period¹ that best represents the typical operation of the mine must be selected. Furthermore, availability of data should be considered. The length of the baseline period is selected based on the scenarios that are to be tested; this can be changed later. For calibrating a compressed air system, a 24-hour period of normal operation is usually sufficient. A longer period may be needed to verify the model.

3.2.3 Investigate operation schedules

A critical aspect of developing an accurate model of a mining compressed air system is to take note of the operational philosophy of the mine. The schedule for operations such as drilling, blasting or cleaning may have a major impact on compressed air requirements at different times of the day. By utilising the operational schedule, simulation scenarios can be optimised for the different air requirements throughout the day.

3.2.4 Verify data accuracy

Data verification involves a process where data is evaluated to ensure accuracy. It is important to verify data that is used for model development, as an accurate representation of the operation of a system can only be achieved if data of high quality is used [60]. The factors that influence a dataset's quality, accuracy and integrity can be summarised as follows:

- Conversion of measurement value [61]
- Storage and collection of the system [62], [63]

¹ A period that best reflects the typical operation before implementation of an energy intervention. This period is then compared with a period after the intervention has been implemented to determine the improvements.

- Traceability of measurement sources [63]
- Measurement equipment accuracy and malfunctions [60]
- Data abnormalities [60]

Therefore, a data verification methodology is utilised to ensure that datasets are of a high quality. In this study, a dataset is built comprising of all the available mining sensors for a 24-hour period of the systems operation. The following checks are performed to verify the quality of a data-sets:

1. Are there missing patches in data?
2. Are the measured values spiking or stagnating?
3. Do the values fall in the expected range and follow a typical trend identified from historical data? For example if a compressor has a maximum power rating of 4 *MW* and historical data shows the machine operates between 3 and 4 *MW*. Values outside this range could indicate bad readings.
4. Do values from independent measurement devices concur? For example, in a case where there are independent flow measurements for pipelines that diverge from a main line. Assuming there are no losses between the measurement devices, the flow through the main pipe should be equal to the sum of measured flows through the divergent pipes.
5. Do related parameters follow the same trends? For example assuming a constant air flow demand, the amount of air flow in a network should correlate with the pressure of the system.

If the dataset passes all the checks, or if the failed checks are explainable or can be corrected, the dataset is regarded as of high enough standard to be used in the simulation.

3.2.5 Resolve missing data

Data that is required to develop the simulation model, such as flows and pressures, may not be actively logged by mine systems. It is often necessary to investigate alternative sources and methods to obtain the data. For example, for process elements where instrumentation is absent, estimations can be made based on assumptions regarding instrumentation on the network, or based on spot inspections.

Air network specifications such as piping sizes, technical layouts, major leak locations or specifications are often outdated or not recorded. Critical data should be obtained through audits and inspections of the system. If a manual inspection is not possible, estimations should be made from the available data.

3.2.6 Summary

This section discussed the method to investigate a compressed air system. It described the processes for acquiring data and information regarding the specific compressed air network, the process to evaluate and authenticate data accuracy, as well as the procedures for dealing with situations where no data is available.

3.3 Develop and verify a simulation model

3.3.1 Preamble

Compressed air networks are comprised of components such as compressors, valves, pipes and other components. This section will discuss the development, calibration and verification of component models that make up a compressed air simulation model.

3.3.2 Select the process boundaries and simulation parameters

The simulation boundaries determine the detail based on which the system process is modelled. For a simple compressed air model, the boundaries can be set around the compressor house. This model would then include only the compressor components, inlet and outlet air flows. Alternatively, a more complex model can be developed by choosing boundaries to include more aspects of the process, such as specific flows on mining levels.

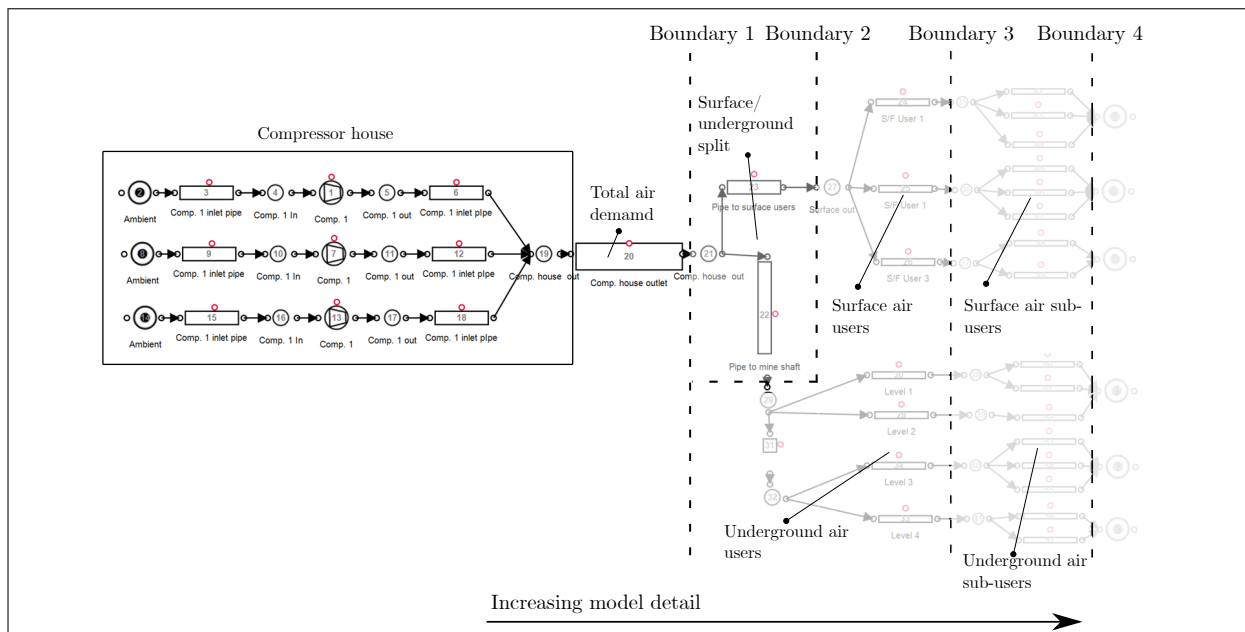

Figure 3.2: Selecting boundaries for the simulation model

The process boundaries should be selected based on the input data available, the accuracy targets and the available time and resources. A more detailed model will allow more accurate simulation. However, it may take more time and resources to obtain the data required to calibrate the model. Figure 3.2 contains an example of different boundary selection for the same system.

Period and data step sizes of the simulation are just as important. The period or duration of the simulation should be determined to ensure that the effects of a scenario are fully tested. Previous studies commonly simulated a “typical” 24-hour period of operation, and most mining compressed air systems follow daily trends and patterns. Therefore, there is no need to simulate a longer period, as day-to-day results would be very similar. A longer simulation may be required for cases where the system operation varies from day to day.

The simulation step size indicates the data resolution. A lower step size will result in a more accurate simulation of the system. However, the processing and data analysis may be affected. In this study, the smallest available step size¹ was selected to ensure that the simulated results would achieve the desired precision.

Compressed air processes such as opening/closing valves or compressors stopping or starting may occur within minutes or seconds. Therefore, higher step sizes (30+ min.) may delay process changes. This delay makes replication of the system control more difficult, and it reduces simulation accuracy.

A higher time-step resolution allows for more precise tuning of controllers and dynamic components. If input data is not available at the desired resolution, the data can be interpolated using the appropriate method. An example of the application of linear interpolation to increase the time-step resolution is shown in Figure 3.3. However, incorrectly estimating the “in-between” data value may adversely affect the simulation accuracy.

3.3.3 Model the air network components

Ambient conditions

Ambient air conditions underground and on the surface change the characteristics of the air, and affects the operation of the system. Figure 3.4 shows the average summer air conditions.

¹ The minimum step size is determined from the logging interval of the input data instrumentation. For example, if all input data is logged at 10-minute intervals, the minimum step size would be 10 minutes.

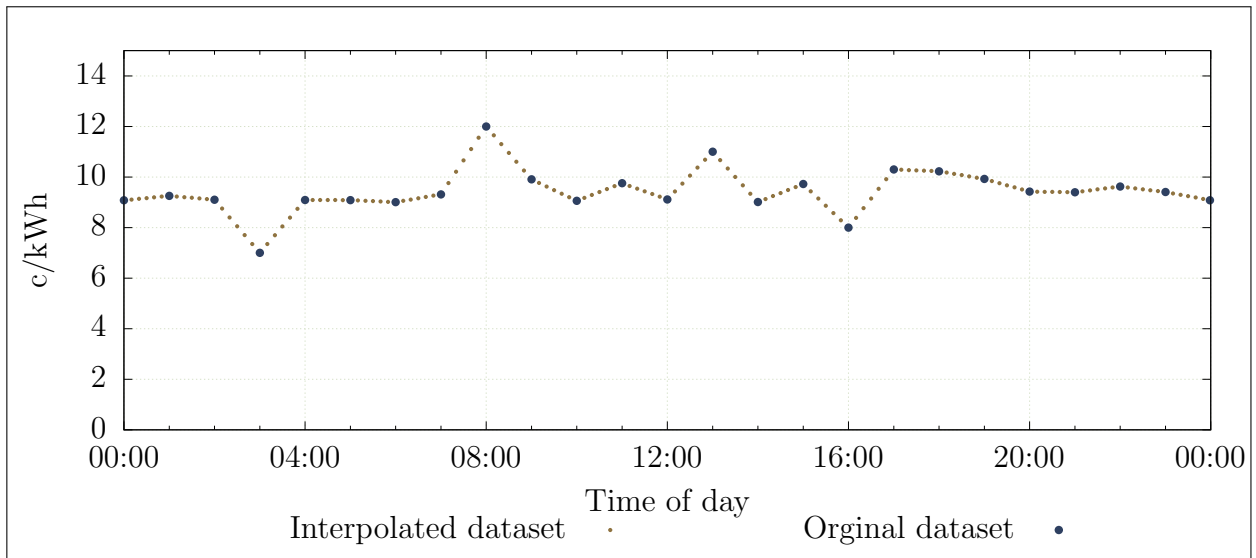

Figure 3.3: Interpolating input data to increase time-step resolution

If no data is available for the specific simulation period, the conditions can be estimated by scaling this profile.

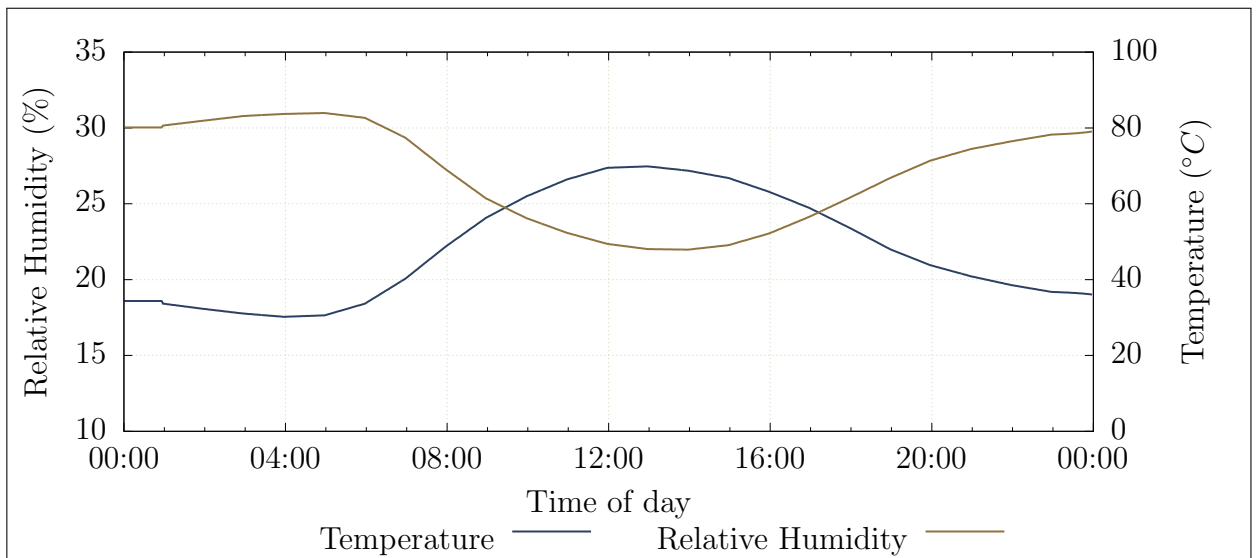

Figure 3.4: Average summer surface ambient air conditions at a South African gold mine

The assumption is made that underground conditions remain constant at each mining level. Pressure and temperature increase with depth as a result of auto compression and rock face temperature. Therefore, the conditions can be estimated using only the depth at each level and historically logged data.

In PTB an air condition is configured using the interface shown in Figure 3.5. The interface allows the user to enter pressure, temperature and humidity profiles for the simulation period as well as a relative elevation of the node in the network.

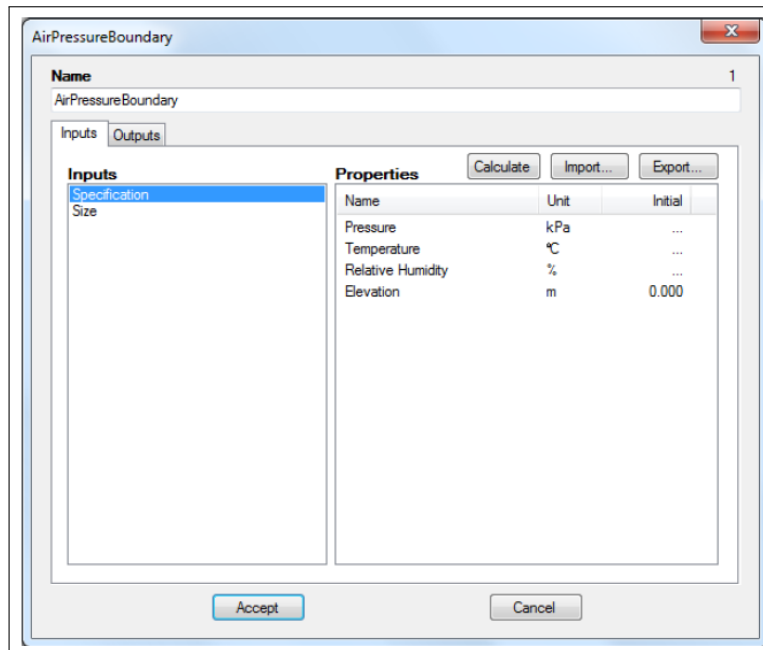

Figure 3.5: PTB air boundary configuration interface

Air pipes

Pressure losses occur over compressed air networks due to friction within the pipe. These losses should be taken into account in the simulation for large piping networks. A pipe model is used to account for these losses, which are defined by the *Darcy-Weisbach equation*¹:

$$\Delta P = \frac{fL\rho V^2}{2D}$$

Where the pressure difference ΔP is a function of:

Parameter	Definition
f	Friction coefficient
L	Pipe length (m)
D	Pipe diameter (m)
ρ	Air density (kg/m^3)
V	Average velocity (m/s)

The pipe component may be used as a valve by controlling the open fraction between 0 and 1. Modelling the valve flow characteristics is discussed in Section 3.3.3 - *Compressed air controllers*.

¹ B. Glenn, 'The Darcy-Weisbach Equation,'[Online] <https://bae.okstate.edu/faculty-sites/Darcy/DarcyWeisbach/Darcy-WeisbachEq.htm>, [Accessed 20-05-2017]

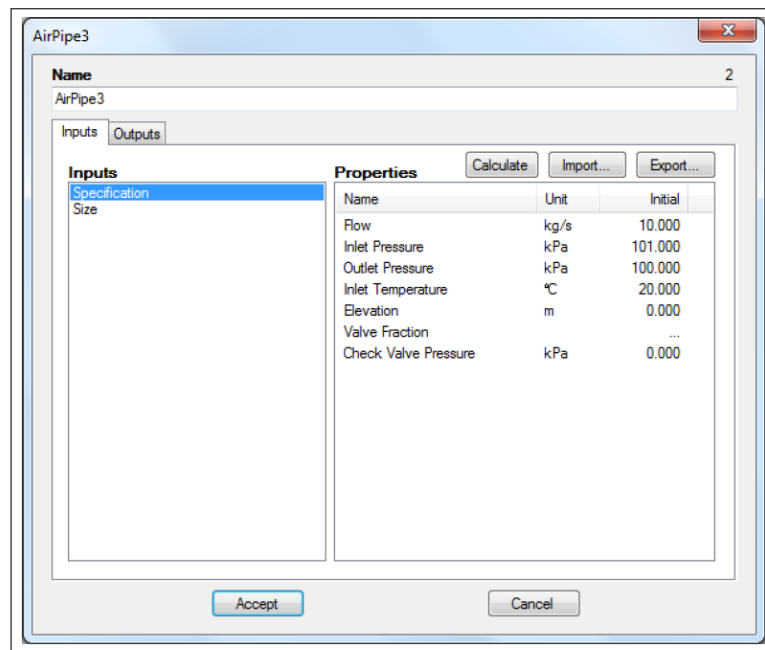

Figure 3.6: PTB air pipe configuration interface

A pipe section can be configured on PTB using the interface shown in Figure 3.6. If the pipe parameters are known, they can be entered with the calculate function to configure the pipe. If the parameters are not known, the default values may be used. These values can then be tweaked whilst calibrating the model to ensure the input and output conditions match actual measurements.

The configuration parameters of the component include a mass flow given inlet and outlet pressure and temperature, an elevation, a check valve pressure (used to induce one-way valve behaviour), and finally a valve fraction profile.

Compressors

The following three compressor models were investigated, each with varying complexity

- Air compressor model
- Dynamic compressor model
- Positive displacement compressor model

The air compressor is a general, simplified model that requires minimal user input by making several assumptions. This model is useful when parameters for a compressor are not available. Alternatively, the air compressor model is ideal when doing a quick or preliminary simulation. However, it is not ideal for detailed simulations that require more precision.

The dynamic compressor components are more complex, and they take into account factors such as heat generated by the polytropic process and mechanical inefficiencies. The model works by creating a pressure ratio in the network, inducing a flow. Hence, the model can be used more accurately and for more complex simulations than the general compressor model. However, it should be noted that the dynamic compressor is simplified by several assumptions, for example, a constant efficiency at varying loads.

Another compressor model, the positive displacement compressor, generates pressure by forcing a flow in the network. When using this model, the flow rate is not a function of the pressure ratio. This limits the model as multiple compressors cannot be configured in series.

For most scenarios, the dynamic compressor model is very suitable. The dynamic compressor is modelled by fitting a quadratic curve through three points of operation to obtain an equation for corrected mass flow as a function of the pressure ratio. This characteristic curve of a compressor (as shown in Figure 3.7) can be accurately estimated even when only one data point is available by making approximations for the zero flow and pressure points on the curve.

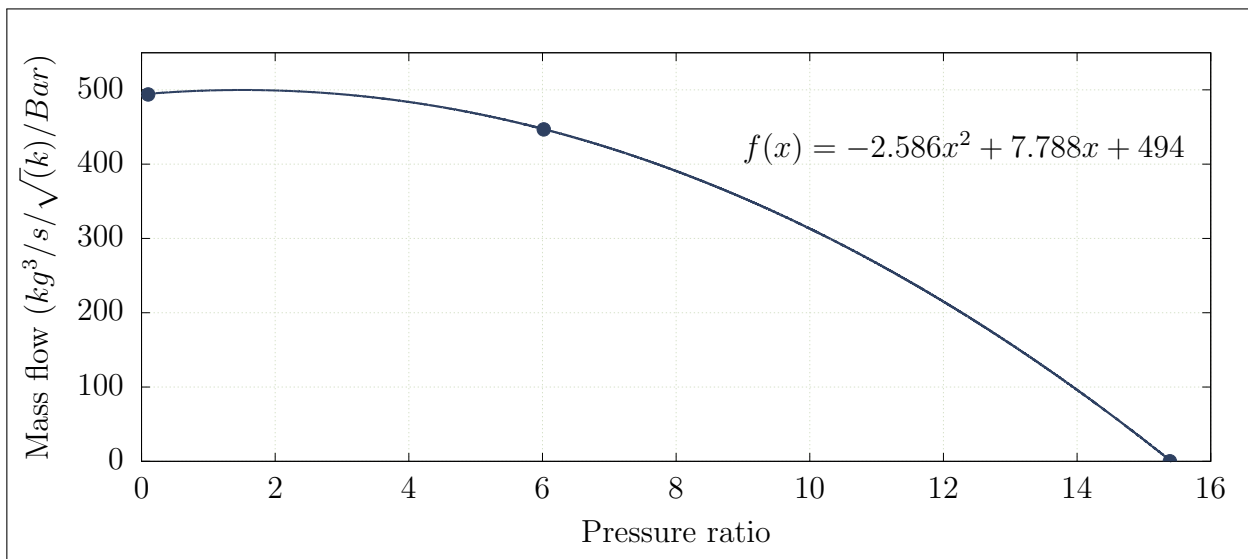

Figure 3.7: Estimating the characteristic curve of a compressor by fitting a quadratic function to points of operation

Figure 3.8 shows the configuration parameters for the air compressor model. The model requires a pressure ratio, flow and efficiency rating at the three points of operation previously discussed. In addition, the relative elevation of the compressor, polytropic coefficient and additional flow and efficiency factors are necessary to accurately model the compressor. Once the flow characteristics of the compressors are configured, the efficiency and polytropic

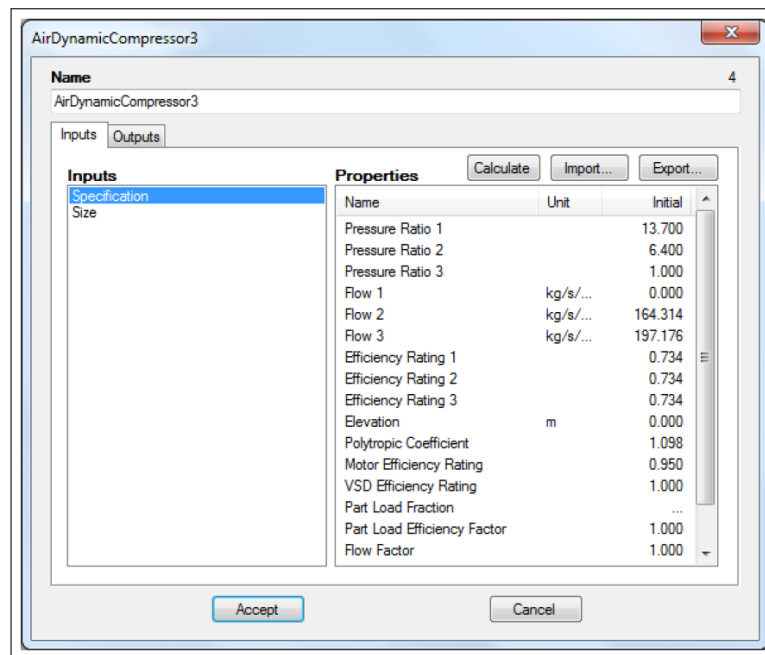

Figure 3.8: PTB air compressor model configuration interface

coefficient parameters are calibrated such that the output power and air temperature match the actual or estimated outputs of the compressor.

Once the models have been accurately calibrated, the compressor component integrates into the air network in the arrangement shown in Figure 3.9. The compressor is connected to the inlet air source via an inlet pipe and air node, and the rest of the network via an air node and outlet pipe. The additional pipe components allow the inlet and outlet conditions to be monitored and controlled in the simulation.

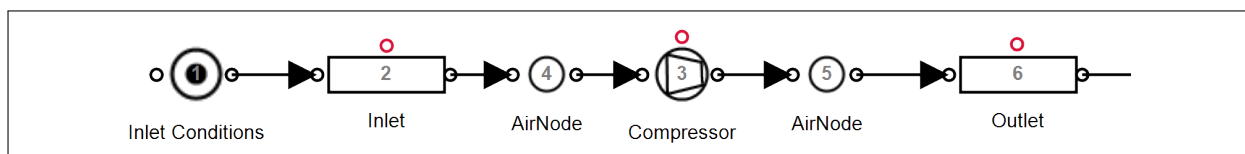

Figure 3.9: Integrating the compressor component into the simulation

Air flow demands

A flow demand represents any air flow leaving the network. Flows leaving the network include any air-consuming equipment such as drills and agitators, as well as losses by means of air leaks and open pipes. The air flow is dependent on pressure and the specific resistance to flow of the outlet.

The resistance of the flow demand can be obtained using the inlet pressure, outlet pressure and flow. If the flow is not known, a reasonably accurate estimation can be made by calculating the expected flow from the size of the outlet. However, this estimation will affect the accuracy.

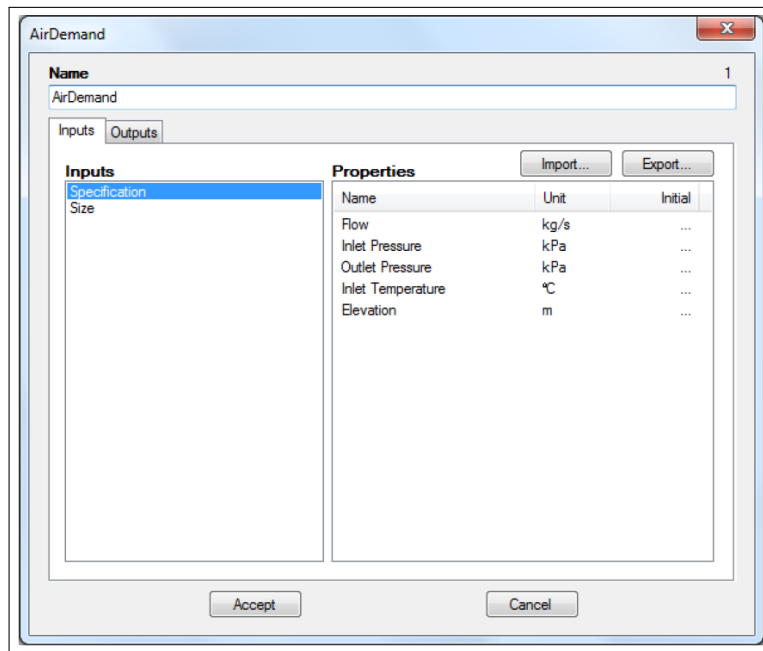

Figure 3.10: PTB air demand component configuration interface

The air demand component is calibrated on PTB using the interface shown in Figure 3.10. The component allows for flow, input pressure, output pressure, temperature and elevation profiles to be set for the period of the simulation. This is especially useful when modelling air usage as air demand may vary throughout the day. For example, a mining section may utilise more machines during certain periods of the day. A schedule and flow profile is used to replicate this in the simulation. Figure 3.11 shows how a calibrated air demand or leak is integrated into the simulation model on PTB.

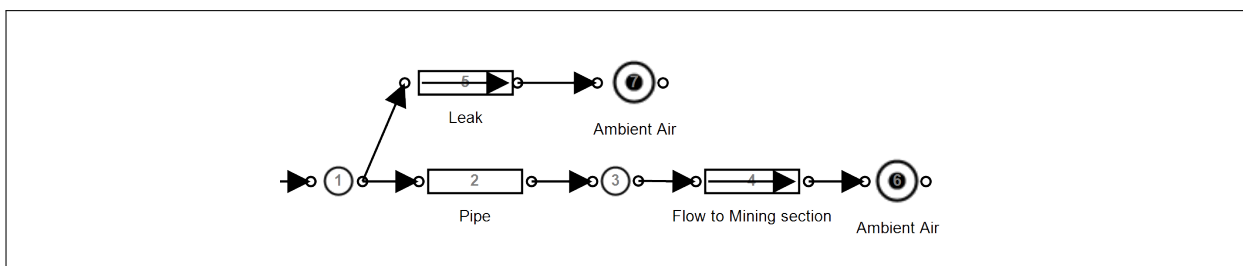

Figure 3.11: Implementing flow demands and leaks into the simulation

Compressed air controllers

Simulation components require dynamic control to replicate the operation of the actual air network. Control is typically implemented on compressors and valves throughout the network to modulate according to set-points and schedules. It is important to not only include the

controllers in the simulation, but to replicate any nonlinearities, limitations and response delays related to specific types of control. Implementing these control factors will ensure that the model reacts in the same way as the actual network would, thus improving accuracy.

On a typical mine, a compressor's power output is controlled to ensure that the discharge pressure matches a specified set-point. This control is achieved through either Variable Speed Drives (VSDs) (or Variable Frequency Drives (VFDs)) or guide vane control. In PTB, valve or compressor control can be replicated using a Proportional-Integral (PI) controller as shown in Figure 3.12. For the control system models in Figure 3.12, outlet pressure is used as feedback to the compressor and a valve controller.

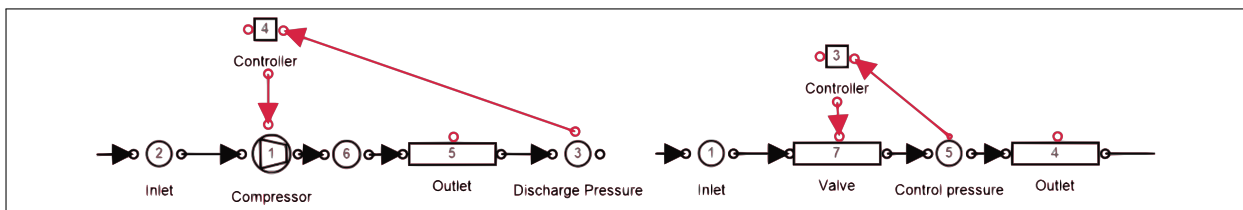

Figure 3.12: Control components in Process Toolbox

Guide vanes are used to control pressure/flow of compressors in mining air systems. Guide vane control entails controlling the position of the inlet guide vane. The guide vane is opened or closed to control the compressor's discharge pressure. Manipulating the guide vane position will affect the output power that the compressor imparts into the system.

Figure 3.13 shows the relationship between power and guide vane position. A relationship between guide vane position and compressor output can be used to estimate the effect of guide vane control. The model should take into account the minimum guide vane position limit that is typically set at around 40% open. As illustrated in Figure 3.13, this control position maps to an electrical power for the compressor of about 60% of the maximum rated power for the compressor. When a higher pressure is required by the mine than can be obtained with all the compressor guide vanes fully opened, another compressor is needed to operate in the system.

In PTB, the guide vane controller is modelled using a PI controller. The non-linear limitations of guide vane control must be implemented in the controller. The control limitation is applied in the model by using a minimum control output limit that matches the minimum power reduction achieved by closing the guide vane to its minimum position.

¹ Data recorded from a guide vane controlled compressor on a mine over a period of six months

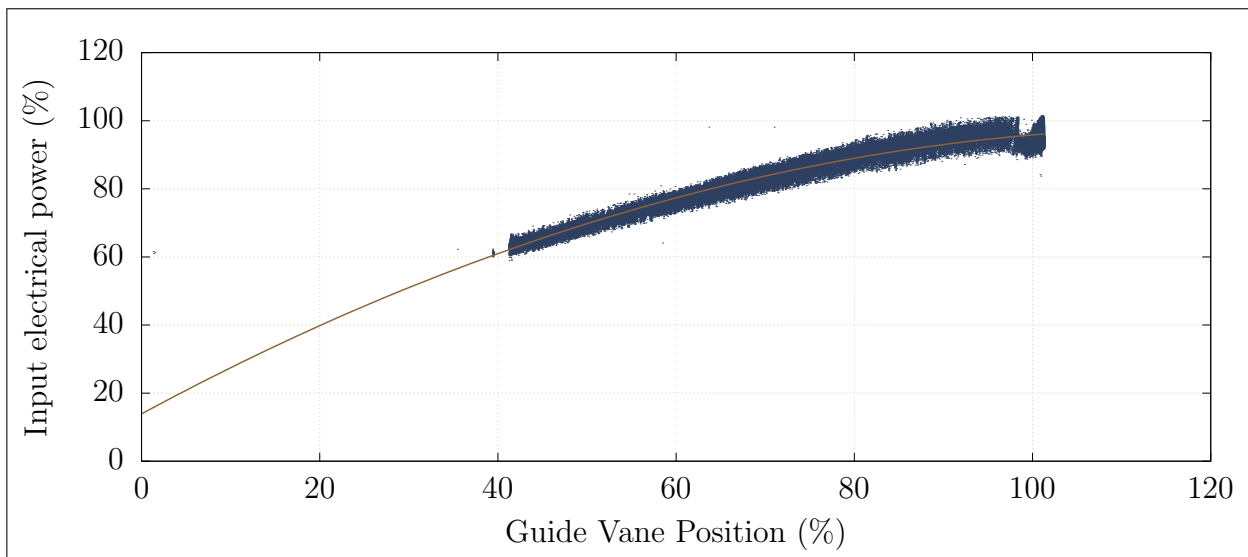

Figure 3.13: Modelling the compressor control from a guide vane¹

Mines make use of control valves at underground sections to adjust the pressure at individual mining stations independently [64]. Controlling of valve components is performed similarly as control of the compressor components. Figure 3.12 shows that the outlet pressure is used as feedback for a PI controller. The controller's output is mapped to the valve position of a pipe component. This allows the controller to manipulate the valve for the desired pressure/flow.



Figure 3.14: An example of a compressed air control valve[65]

Compressor after-cooling

The air compression process generates significant heat. Compressed air at high temperatures contains a significant amount of water vapour. After-coolers are installed on compressed air systems to prevent condensation in the air network, to improve the system capacity and to protect equipment from excessive heat [25].

After-cooling reduces the output air temperature of the compressors. This cooling can affect

the operation of the network. Hence, including after-cooling in the simulation model should improve accuracy.

Modelling the after-cooling is achieved in PTB using a heat transfer node at the outlet of the compressor component model. The heat transfer parameters shown in Table 3.1 should be calibrated such that the input and output air temperatures match measurements in the actual system. Based on historically logged data and knowledge of mining operational trends, an assumption of 40°C can be used for a compressor discharge air temperature of 60°C if no measurements are available for a mining compressed air system.

Table 3.1: The input parameters for the after-cooling simulation model

Parameter	Definition	Unit
A	The heat transfer area	m^2
UA	Heat transfer coefficient	$kW/^\circ C$
T_{amb}	Ambient air temperature	$^\circ C$

Depending on the accuracy requirement, after-cooling can be excluded from the simulation. Post after-cooling, compressed air is usually still warmer than ambient conditions. Air temperatures underground can be accurately matched by including heat transfer for compressed air pipelines.

Model calibration process

Once the network of component models has been constructed, calibration is performed to ensure the model reacts to input and output conditions with minimal error when compared to the actual system. Component models were calibrated individually as follows:

- Guess or estimate a starting configuration for the component model
- Run a simulation using known input and output conditions
- Determine the simulation error for the component
- Adjust component configuration
- Repeat steps 2 to 4 until the error is reduced to an acceptable level

Once all component models have been accurately calibrated, the simulation model should be verified.

3.3.4 Verify the simulation model

Based on the review of literature in Section 2.4.8, it was determined that MAE and the coefficient of determination are the most effective methods for measuring model accuracy. Therefore, both measures are utilised in the model verification in this study. These measures are obtained by comparing the major simulation outputs (total system power, flow and pressure) to actual data from the system. R-squared and MAE metrics are calculated by applying the applicable methodologies discussed in Section 2.4.8.

For this study, the selected verification constraints were selected as:

$$r^2 > 0.9 \text{ and } Err\% < 5\%$$

For the purposes of this study, the model is considered accurate if all these limits are met for the power, flow and pressure of the system. As an extra measure, the relative error of the output for the minor model components should be $> 85\%$ of the actual data. To obtain the true error of the model, instrumentation measurement error should be combined with the calculated simulation error.

Furthermore, periodically repeated simulations could be used to verify simulations more definitively. To perform the repeated simulation verification, the input variables should be updated for each new period. The output values of the simulation should then be compared with actual measurements. For each simulation, the verification constraints should be met.

3.3.5 Select simulation inputs

The inputs of a simulation are any parameters that do not remain static or follow the same profile in the day-to-day operation of the system. Examples of such parameters in a compressed air simulation are the following:

- Surface ambient conditions
- Machine operation schedules
- Air demands
- Operational changes

Assuming the air conditions remain relatively similar, changing the simulation baseline period for a calibrated simulation should require only the updating of the input parameters.

In reality, a change in input will affect the flow properties within the network. Specifically, changing fluid parameters will affect friction factors. However, in this dissertation, pipe losses were significantly simplified. The assumption was also made that the difference in input conditions between baseline will have a negligible effect on model accuracy.

In Figure 3.15, an example is shown of a changing compressor schedule where an input parameter would need to be updated in the simulation.

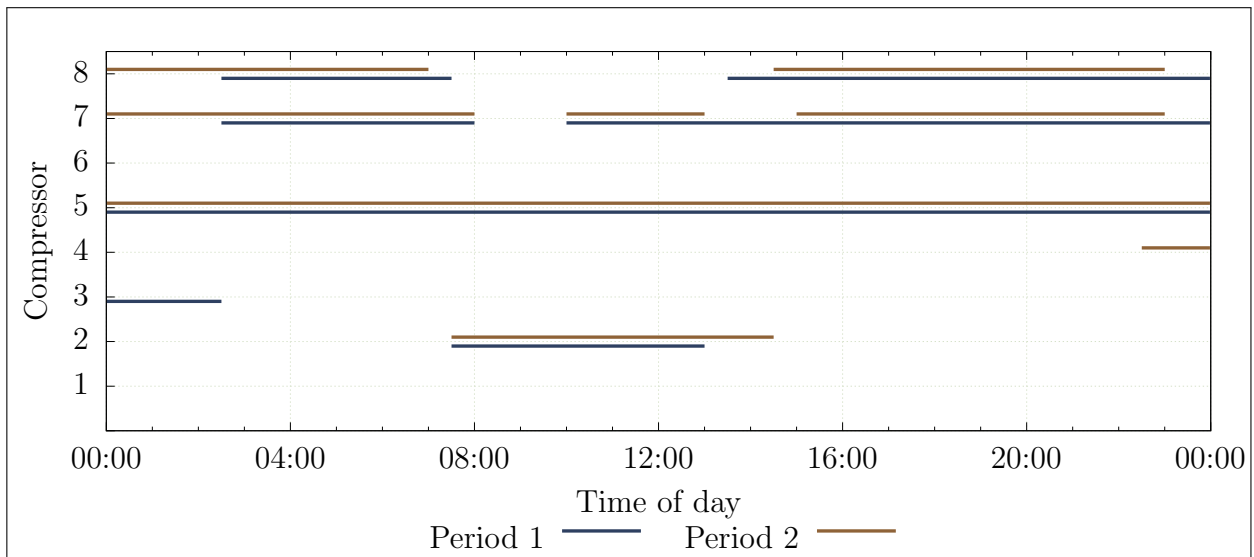

Figure 3.15: Example of two baseline periods, showing a changed compressor schedule

3.3.6 Periodic simulation

Periodic simulation refers to the repetition of simulations over subsequent periods to determine the sequential accuracy of the model. Sequential accuracy is important to verify that the model is valid in general and not just for a single period. This simulation will also indicate where operational changes have occurred, as the simulation accuracy will be reduced.

The following procedure, as illustrated in Figure 3.16, was followed to implement periodic simulation:

- Collect simulation input data periodically for each simulation interval
- Import input data series into the simulation model
- Execute/solve the simulation
- Export the output simulation values
- Compare output data with the system's actual operation and identify major discrepancies
- Trigger the process periodically

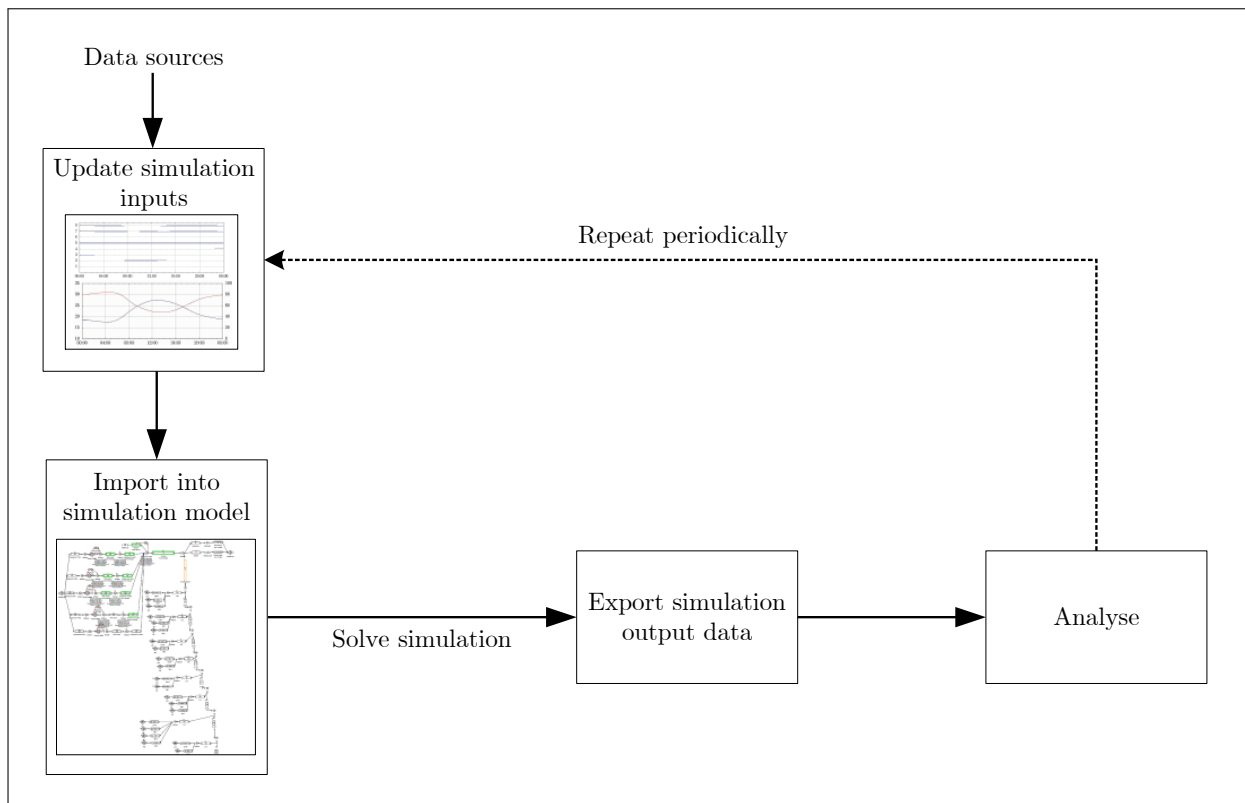

Figure 3.16: The periodic simulation process followed in this analysis

3.3.7 Summary

In this section, the sub-processes required for the development and verification of a simulation model were discussed. First, a method for selecting the model boundaries and parameters were reviewed, followed by a discussion on the modelling procedure for compressed air sub-components.

The verification process and the selection of accuracy limits were next (see the analysis performed in Section Section 2.4.8). The simulation input selection procedure was also reviewed and a procedure was provided for repeated/periodic simulation.

3.4 Implement the simulation

3.4.1 Preamble

Once a simulation has been developed and verified, the implementation of interventions and scenarios follows. In this section, the approach towards implementing the simulation methodology, and an analysis of interventions will be discussed.

3.4.2 Execute simulation scenarios

At this point, the simulation model has been verified using historical data. The verified output data series is now used as a baseline upon which interventions can be quantified. The simulation inputs of the model have now been adjusted to create the desired scenario. For example, to create a scenario where a specific compressor is shut down over a period, the input schedule of the compressor is adjusted in the simulation model.

The simulation is then executed, and this process is repeated for each of the scenarios. For each scenario, the desired output parameters must be exported for further analysis.

3.4.3 Quantify operational benefit

With the data for each of the simulated scenarios exported, the relative improvement compared with the baseline should now be quantified. This comparison is achieved by analysing the differences between the theoretical baseline and optimised data series, as shown visually in Figure 3.17. The theoretical improvement was achieved by reducing the power of the baseline data series between 16:00 and 00:00. To quantify the benefit, the saving series is calculated by subtracting the optimised series from the baseline:

$$Saving_n = Benchmark_n - Optimised_n$$

The average power, pressure or flow improvement is then quantified as follows:

$$Saving_{Ave} = \sum_{n=1}^N \left(\frac{Saving_n}{N} \right)$$

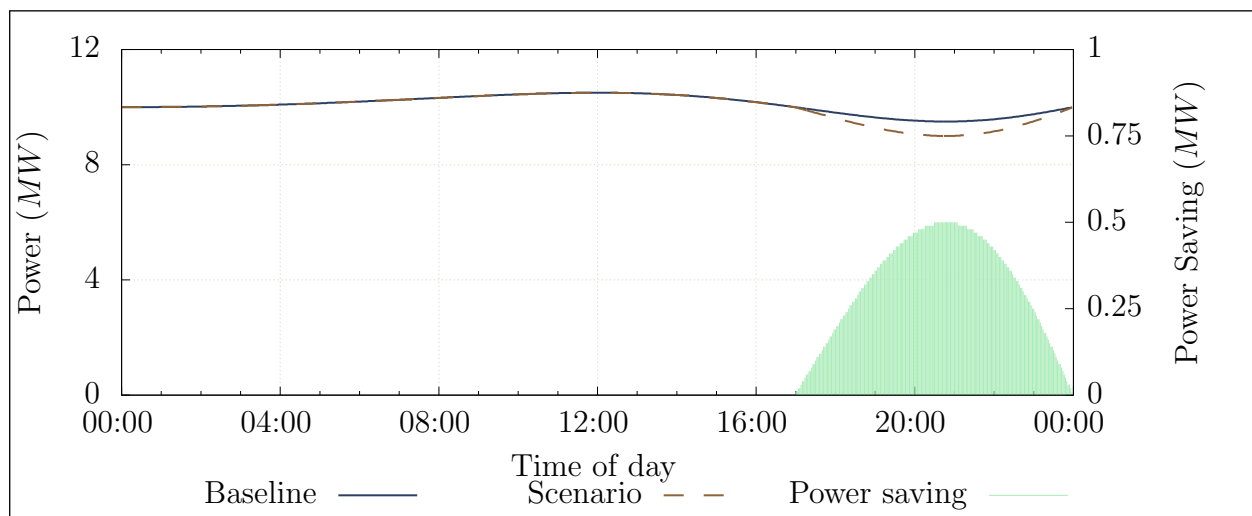

Figure 3.17: Theoretical example of a baseline vs. optimised power comparison

For power data, the expected annual energy cost saving can be calculated using the average weekday energy saving and the tariff structure provided by Eskom. The energy supplier’s weekday Time of Use (TOU) tariffs for both the high demand (Jun – Aug) and the low demand (Sep – May) seasons are shown in Figure 3.18.

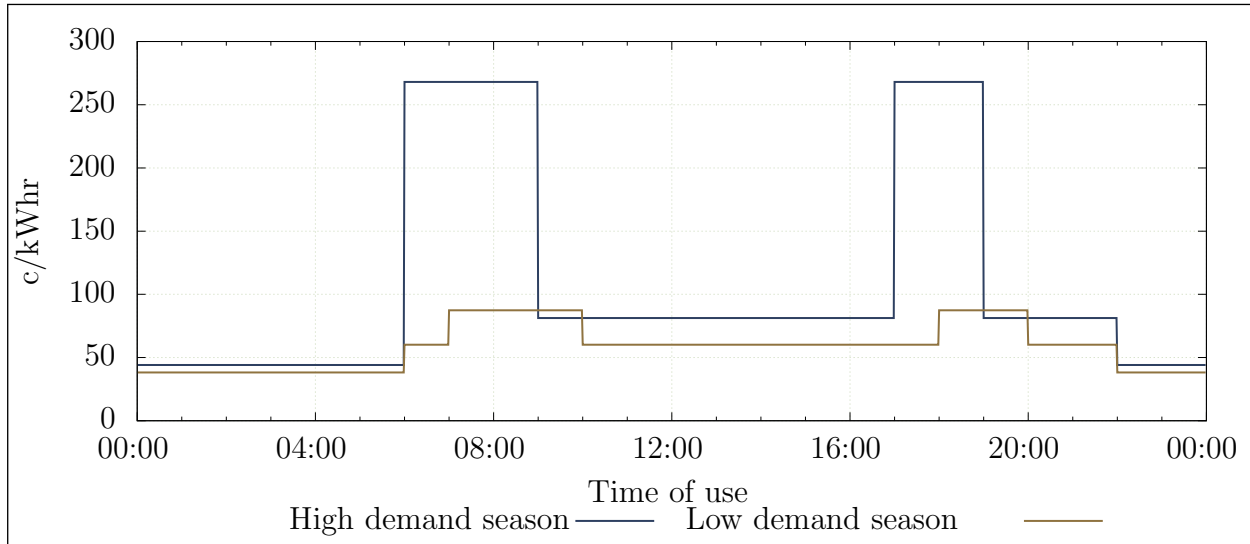

Figure 3.18: Eskom’s weekday time-of-use (TOU) tariff structure¹

Estimating the cost benefit of improvements in pressure delivery is harder to quantify. Instead, the average pressure benefit for a period should be provided in kPa . For example, “The simulation indicated an x MW saving with an additional pressure improvement of y kPa during the drilling shift”.

3.4.4 Report results to the mine

Once the benefits for each simulated scenario have been calculated and quantified, the interventions should be prioritised according to the greatest benefit for the mine. The implementation costs and pay-back periods of the interventions can also be considered in this process.

The results and recommendations should be submitted to responsible mine personnel in the form of a report (an example report is shown in Figure 3.19). At this point, the process of implementation becomes the mine’s responsibility. The mine may require further validation of the results through practical testing.

¹ Eskom, “2017/18 Tariffs and charges,” [Online] <http://www.eskom.co.za/CustomerCare/TariffsAndCharges/Pages/Tariffs.And.Charges.aspx>, [Accessed 28 June 2017]

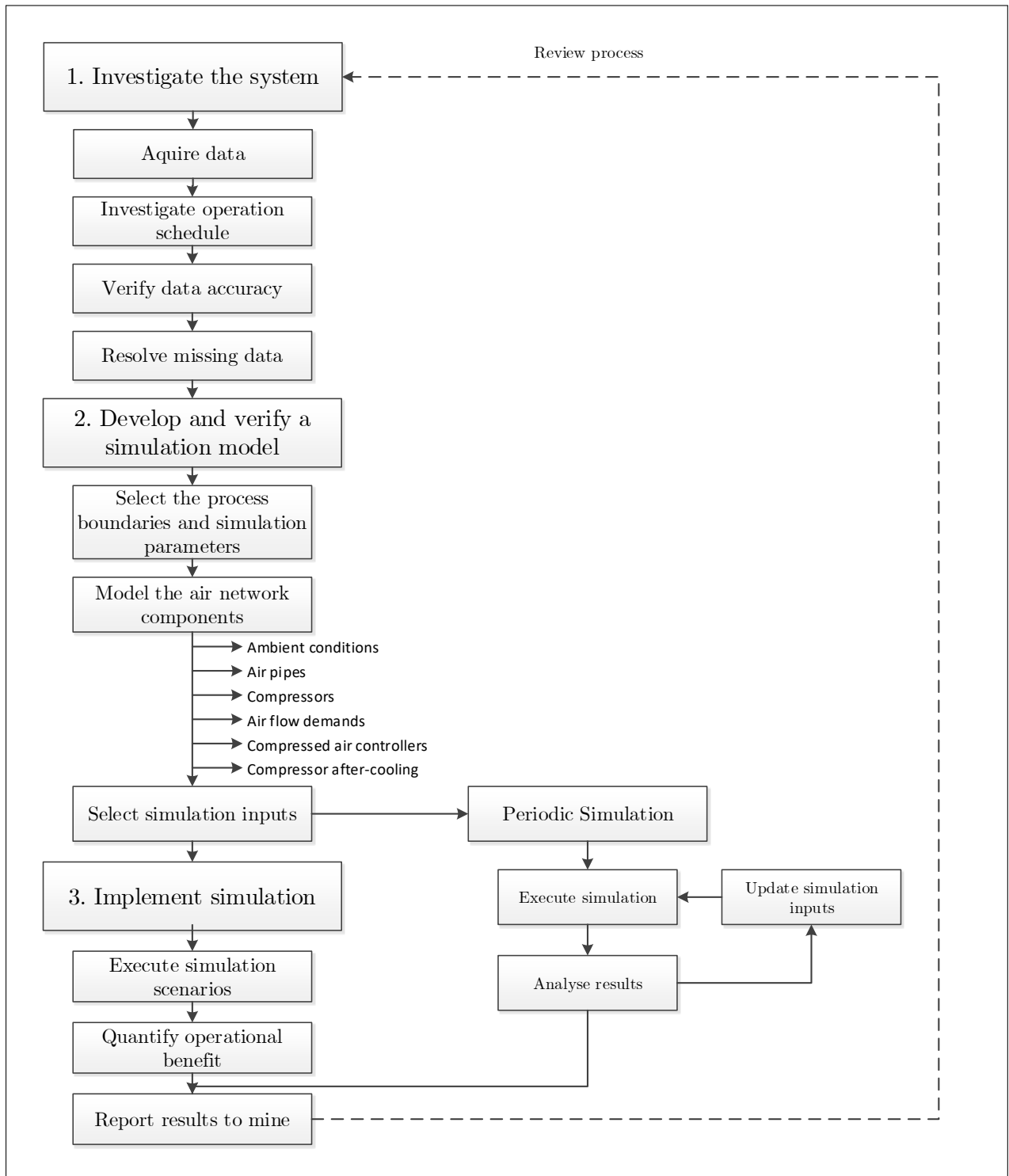

Figure 3.20: Graphical representation of the methodology

CHAPTER 4

Results and validation

“It doesn’t matter how beautiful your theory is, it doesn’t matter how smart you are. If it doesn’t agree with experiment, it’s wrong.” - Richard P. Feynman

4.1 Introduction

This section will validate the developed simulation methodology by means of case studies. Mining compressed air systems were chosen as suitable case studies based on the availability of data and the scope for energy and operational improvement. Two different mines were selected for the study.

Three case studies were performed. In Case Study 1 and 2, improvements were simulated on mine A and mine B respectively. In Case Study 3, periodic simulation analysis was implemented by using the simulation developed for Case Study 2. Based on the results of the three case studies, the potential benefits of compressed air simulations for the South African mining industry are next estimated and discussed.

4.2 Case Study 1: Simulated improvements on mine A

4.2.1 System investigation

Mine A represents a group of three gold mine shafts and a gold-processing plant in the Free State province of South Africa. The mine shafts and gold plant share a compressed air network. Before this study, efforts were made to optimise the system through DSM energy projects. However, there may still be potential for further optimisation. An investigation was performed to gather data and understanding of the system and to identify potential energy and operation improvement strategies.

An air-flow distribution layout was developed for the system (see the simplified layout in Figure 4.1). From this schematic representation, along with information and data, an understanding of the air network's operation was obtained. The system typically utilises 5 MW of instantaneous power. During the drilling shift, the demand increases to 6 MW. Figure 4.2 shows the average weekday power profile that was reported between January and May 2016.

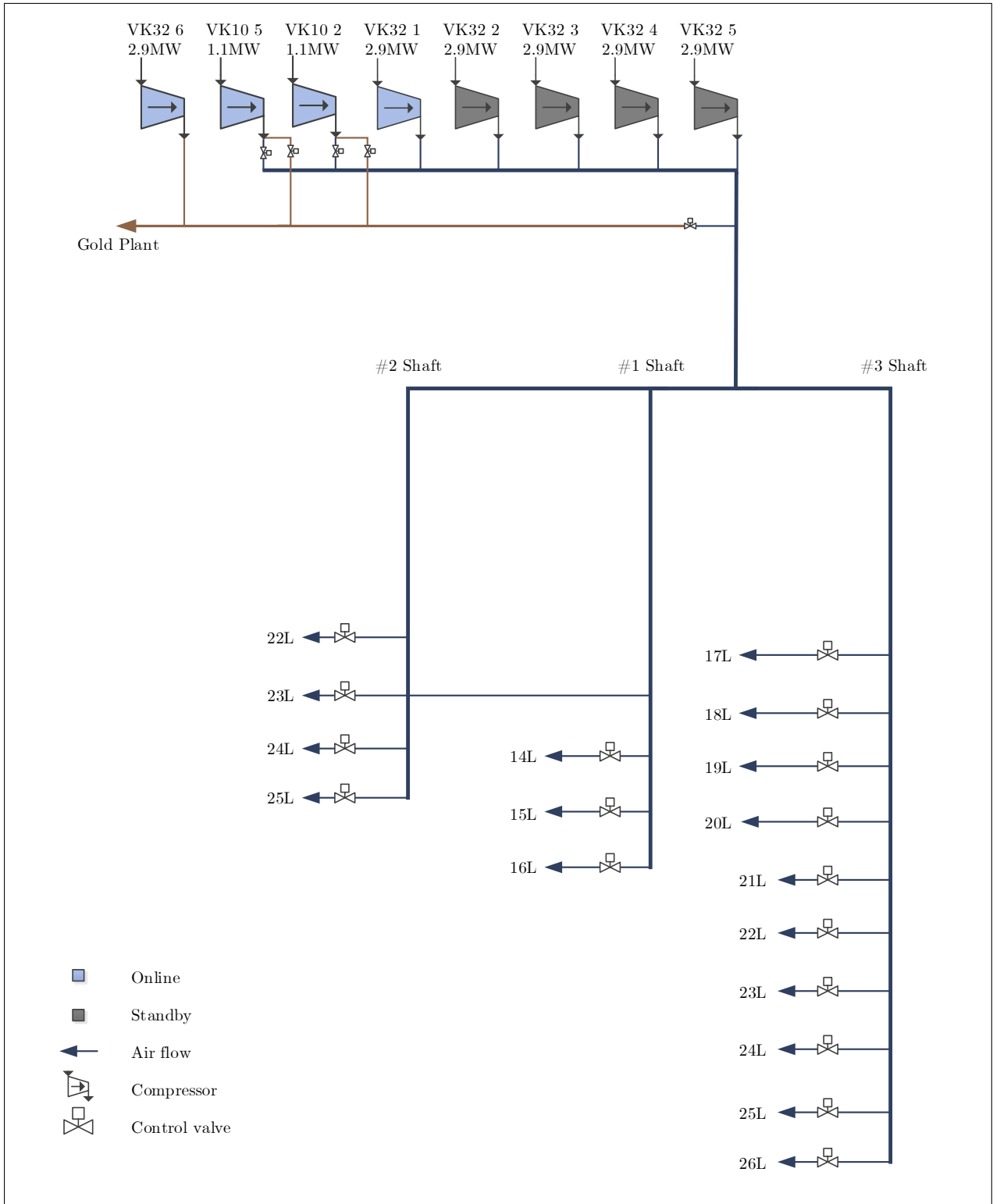

Figure 4.1: Simplified process flow chart of the compressed air network

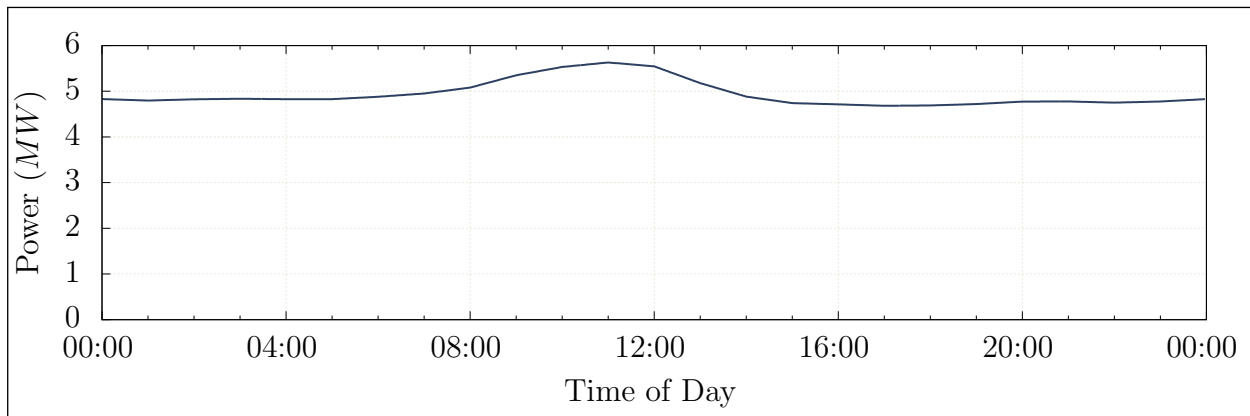

Figure 4.2: Average power profile

Seven compressors were available in the system: five large compressors (VK32) rated at 2.9 *MW* each and two smaller compressors (VK10) with a power rating of 1.1 *MW* each. No more than four compressors were required at one time; the other compressors are therefore on standby. Air was supplied to the sections in three mine shafts, as well as to a gold-processing plant on the surface.

The mine normally operates the compressors with a constant pressure set-point of 500 *kPa*. The set-point is kept high for the gold-processing plant, as it requires constant high pressure throughout the day. This constraint makes it difficult to reduce the set-points of the compressors. It is however possible to control the air supply pressure to the gold-processing plant independently from the rest of the network. The supply to the plant is controlled by the surface valves.

Eskom's evening energy peak time was identified as a period where savings could be obtained. During this time, air was not required underground as blasting was scheduled. Due to the energy tariff structure, interventions during the energy peak time also maximised the financial benefit for the mine. Compressor set-point control and underground valve control were identified as strategies to achieve these savings. Due to the risk of production loss, the mine would not allow the practical testing of the scenario on the actual system. The simulation was therefore required to accurately calculate and analyse the benefits of the compressor set-points. A model was developed to test these scenarios.

4.2.2 Model development

With the data and understanding gathered from the investigation, a model was developed using the PTB software tool and the methodology discussed in Chapter 3. First, the simulation boundary was selected to include the measured flows to each level underground, as well as

to the surface processing plant. For highest accuracy, the simulation step size was set to 30 minutes to match the available data resolution.

The simulation component models were developed and calibrated using the respective methods discussed in Chapter 3. The following assumptions were made to simplify the model development:

- The effect of compressed air after-cooling is negligible
- Heat transfer over the pipe length is negligible
- Underground air conditions are typical¹
- Surface ambient air conditions follow normal summer trends

The model components were calibrated so that the simulated outputs matched data from the real system. The process flow diagram for the simulation is shown in Figure I.1 (Appendix I), while the model data inputs and outputs are described in Table 4.1.

Table 4.1: Data inputs and outputs for the Case Study 1 simulation model

Inputs	Outputs
Level measured flows	Compressor powers
Compressor schedules	Network flows
Compressor set-points	Network pressures
Underground valve set-points	

4.2.3 Verification of the simulation model

Verification was performed to ensure that simulated output accuracy was $> 95\%$. Figure 4.3, Figure 4.4 and Figure 4.5 show the total simulated power, flow and outlet pressure of the compressors compared to the system. The calculated error metrics for the key process parameters are shown in Table 4.2. The average relative percentage error for the total power and flow was 2.78% and 3.0% respectively. The $Err\%$ of the outlet pressure was 0. All the process parameters were well within the target relative error of $< 5\%$ error and $r^2 > 0.9$.

The accuracy of the simulation was checked in more detail to ensure that the sub-component outputs matched the actual measurement with high accuracy. Table III.1(Appendix III) shows the precision of each simulation output compared to the physical measurements.

¹ Typical air conditions were obtained from trends of logged measurement from similar mines.

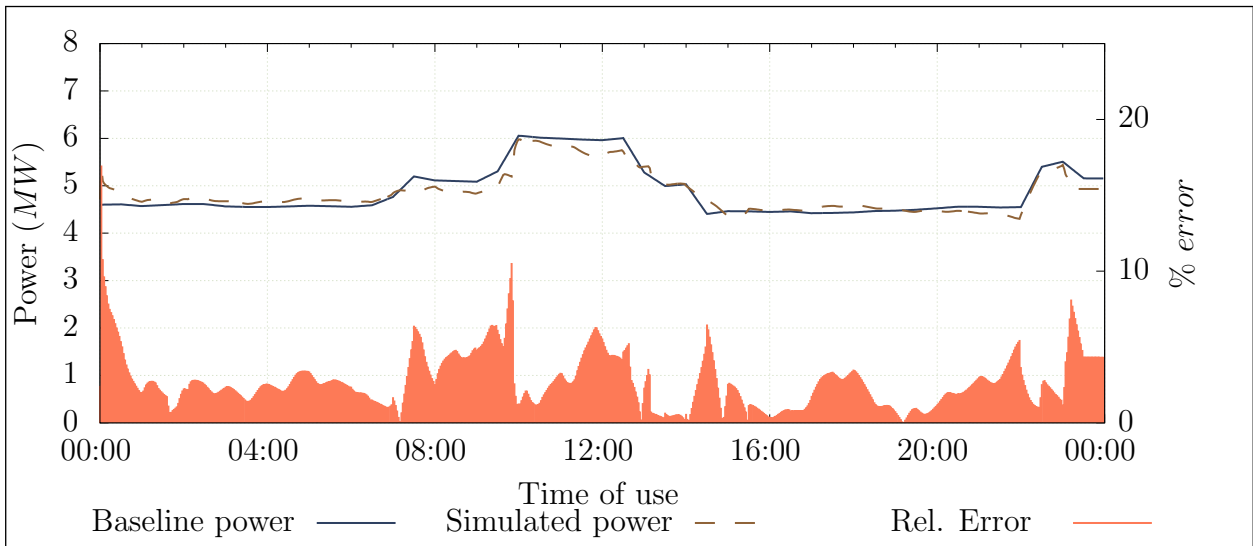

Figure 4.3: Simulated power compared to the actual measurement

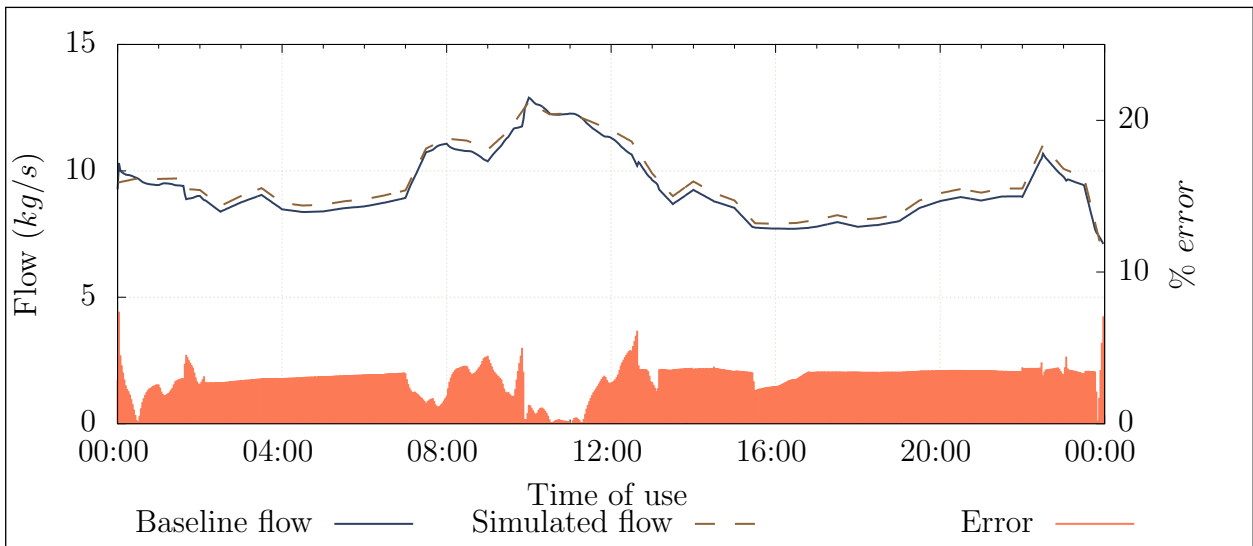

Figure 4.4: Simulated flow compared to the actual measurement

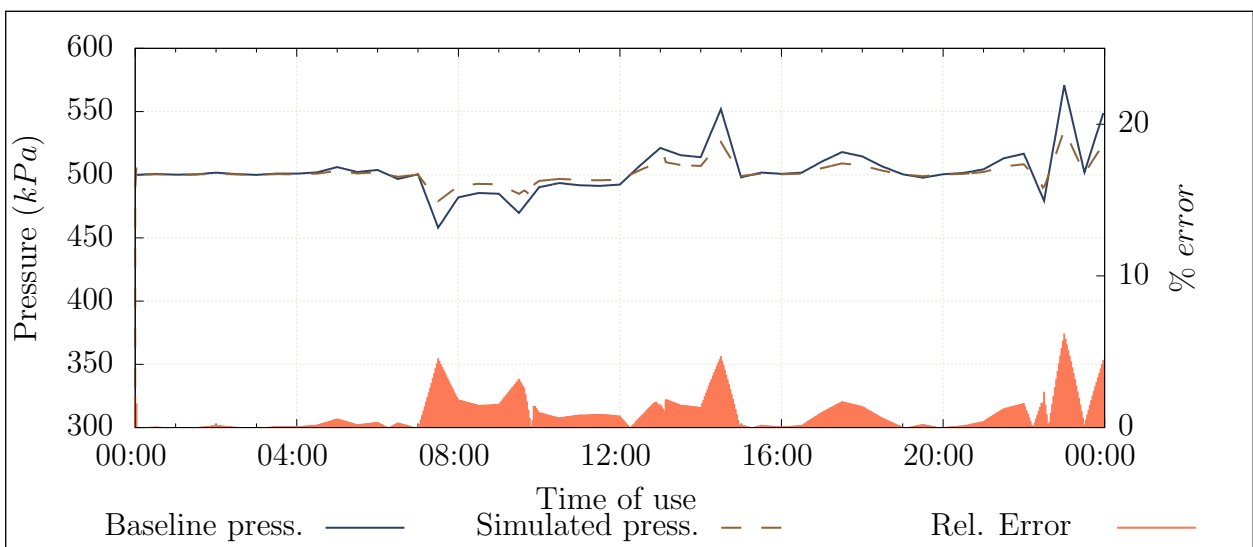

Figure 4.5: Simulated pressure compared to the actual measurement

Table 4.2: Case Study 1: Verification of simulation model

Verification method	Result	<i>Err%</i>
Total Flow		
Mean residual difference	0.25 <i>kg/s</i>	2.73%
MAE	0.27 <i>kg/s</i> error	3.0%
Coefficient of determination	$r^2 = 0.99$	-
Total power		
Mean residual difference	0.02 <i>MW</i>	0.57%
MAE	0.14 <i>MW</i> error	2.78%
Coefficient of determination	$r^2 = 0.91$	-
Compressor outlet pressure		
Mean residual difference	0.03 <i>kPa</i>	0.01%
MAE	0.21 kPa error	0.03%
Coefficient of determination	$r^2 = 0.99$	-

4.2.4 Execution of simulation scenarios

Scenario 1: Compressor set points

The Eskom evening peak tariff time occurs during the blasting shift. During this time, the underground pressure requirements are lower than for the rest of the day. Reducing pressure in the network reduces power, as less work is required from the compressors. In addition, losses caused by air leaks are reduced. However, lowering the pressure set-point of the compressors requires that the air to the gold plant be independently controlled.

For the simulation model the compressor set-points were reduced to 420 *kPa* – the minimum allowed compressor set-point during the drilling shift. The compressor schedule was changed to allow independent control of the gold plant pressure, which was maintained at 490 *kPa*.

The results of the simulation, shown in Figure 4.6 indicated an average power reduction of 0.46 *MW* Peak-Clip (PC). This energy optimisation relates to R0.37m per year energy cost saving to the mine.

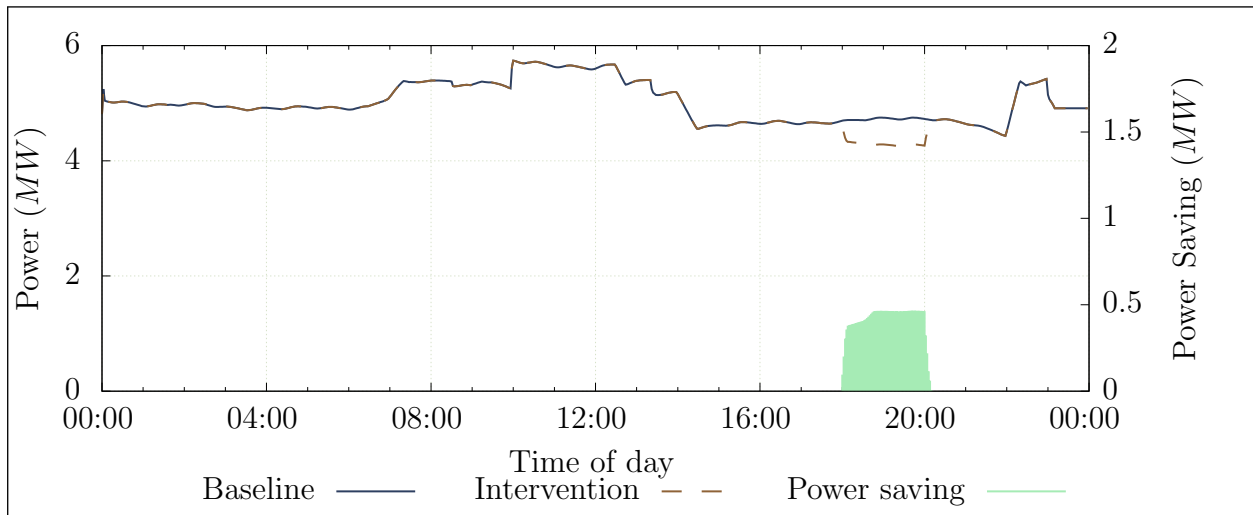

Figure 4.6: Energy savings by reducing compressor set-points

Scenario 2: Control valve set points

An alternative scenario was to reduce the pressure at the control valves at each level. By reducing pressure at the control, set-points could be lowered to the minimum requirement per level. This reduction could lead to higher savings than could be achieved through compressor set-point reduction. The scenario would be relatively easy to implement as it would not require any changes to the compressor control schedule.

Air pressure set-points were reduced to 300 kPa at the underground control valves during the evening peak period. Analysis of the simulation results showed a 1 MW average PC saving. The intervention would lead to an annual cost saving of R0.91m.

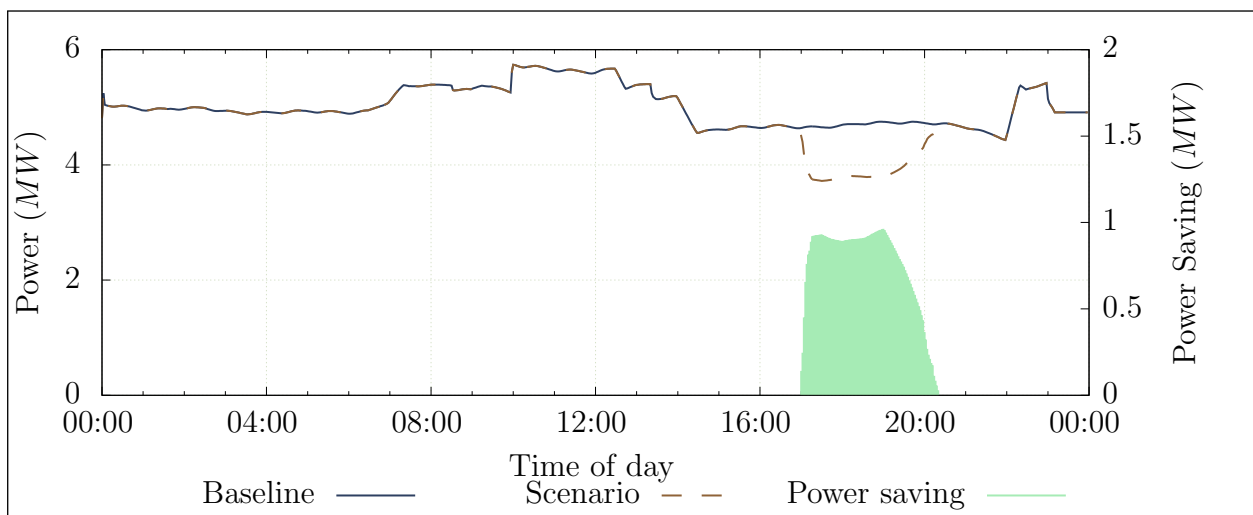

Figure 4.7: Scenario 2 - Simulated peak-time power reduction

4.2.5 Comparison of scenario results

A comparison of the scenarios (see Table 4.3) showed that Scenario 2 had a larger peak energy impact than Scenario 1. Further savings could be achieved through a combination of the two scenarios, as well as by investigating set-point reductions during other periods of the day.

Table 4.3: Comparison of Mine A's simulated scenarios

Scenario	Power saving	Cost saving per annum (p.a.)
Scenario 1 results		
Reducing compressor set-points	0.46 MW PC	R0.37m
Scenario 2 results		
Reducing underground pressure during evening peak	1.0 MW PC	R0.91m

4.2.6 Validation of results

Scenario 2 was implemented on the actual compressed air system. An energy saving of just under 1 MW PC was recorded when compared with the 2016 power baseline profile. These results matched the simulated scenario closely. Figure 4.8 shows the practical result compared with the simulated and baseline power profiles. The average evening peak power clip achieved on the actual system was 0.95 MW. This energy improvement was within a 5% error of the simulated result.

4.2.7 Summary

A case study was implemented on a mine compressed air network in the Free State. Following the simulation methodology, an investigation was performed to gather data and identify potential interventions. A simulation model that was developed to test scenarios revealed a PC saving of 1 MW, which would result in a cost saving of R0.9m. The simulation was validated with results from implementation on the actual system.

4.3 Case Study 2: Simulated improvements on mine B

4.3.1 System investigation

Case Study 2 was performed at a large South African gold mine. The mine utilises five compressors to supply compressed air to various surface and underground operations. An

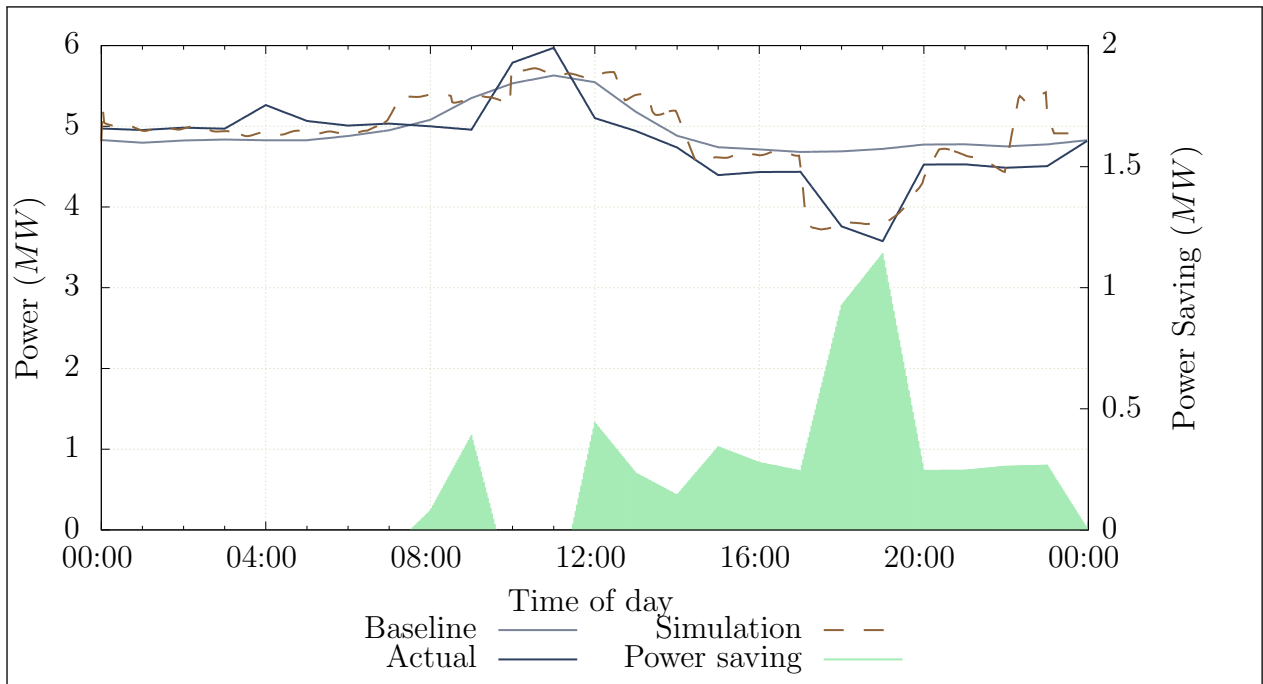

Figure 4.8: Actual power savings achieved on the system

investigation was carried out to gather the data and information required to build a simulation model of the network, as well as to identify potential cost-saving simulation scenarios.

A basic air distribution layout was developed for the system. Figure 4.9 illustrates the system process in detail, and indicates the flow distribution to the three mining shafts and gold-processing plant.

Data related to the mine scheduling, as well as critical limits and set-points of the compressed air system, was obtained from various mine personnel. From this, a general understanding of the operation was obtained. Critical data parameters such as power, pressures and flows of the system were gathered from the Supervisory Control and Data Acquisition (SCADA) systems as well other data measurement sources. This information was used to develop and calibrate the simulation model.

Strategic level investigations were performed on the significant mining levels to map and measure the locations and air usage for the cross-sections, refuge bays, major leaks and other compressed air consumers on each level. An example of a resultant schematic from the underground investigation is shown in Figure IV.1 (Appendix IV). The information gathered from the system investigations was subsequently utilised to develop and calibrate a simulation model.

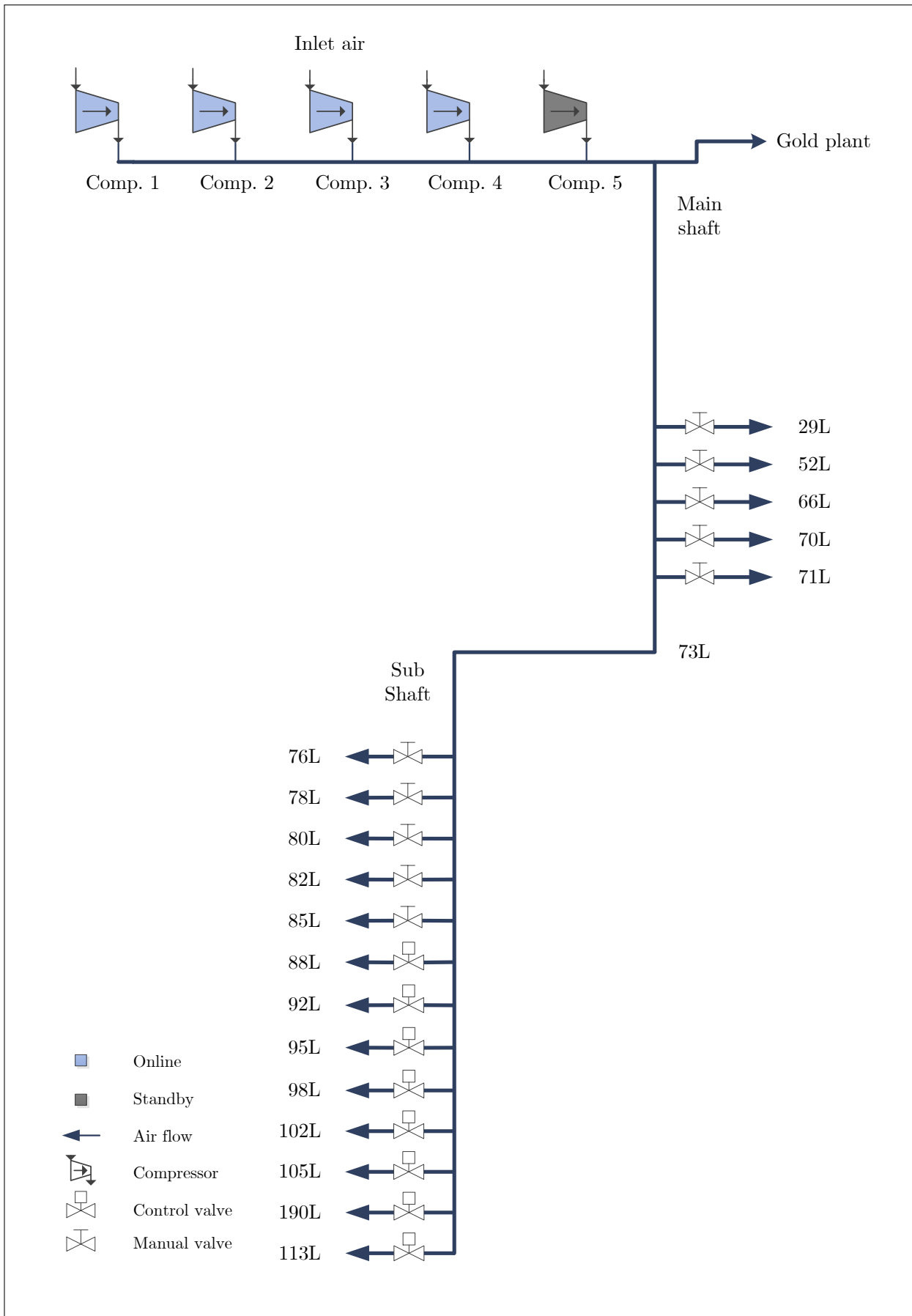

Figure 4.9: Process schematic of the compressed air network

4.3.2 Model development

Based on the investigation, a compressed air network was modelled in PTB. The methodology described in Chapter 3 was utilised in this process, and the following assumptions were made to simplify the model development:

- After-cooling reduced compressed air temperature from 100° Celsius to 40° Celsius
- Typical underground air conditions existed¹

The boundaries of the baseline simulation were selected based on the available data for the system. For maximum accuracy, the simulation step size was set to the two minutes to match the resolution that was available from the data source. The model components were calibrated so that the simulated outputs matched data from the real system. The process flow diagram for the simulation is shown in Figure I.2 (Appendix I). The model data inputs and outputs are described in Table 4.4.

Table 4.4: Simulation inputs and outputs

Inputs	Outputs
Level measured flows	Compressor powers
Compressor schedules	Network flows
Set-points	Network pressures

Verification of the simulation model

The verification methodology was used to verify the simulation model by comparing the simulation outputs to actual measured values. Since the compressor’s outlet pressure often does not match the set-point, the measured outlet pressure was used as set-points for the compressors to verify the power and flow outputs. The set-points ensured that the pressure in the network was identical to that of the actual system.

With the simulated network pressure almost identical to the actual, the power and air-flow outputs were compared with outputs from the physical system. Figure 4.10 and Figure 4.11 show the comparison of the total power and flow of the system with the physically measured values for that same period. The relative error of these process parameters compared to the real network was 1.02% and 1.36% respectively. This simulation error was within the acceptable error limits. A summary of the verification metric for the major process totals is provided in Table 4.5.

¹ Typical air conditions were obtained from trends of logged measurement from similar mines.

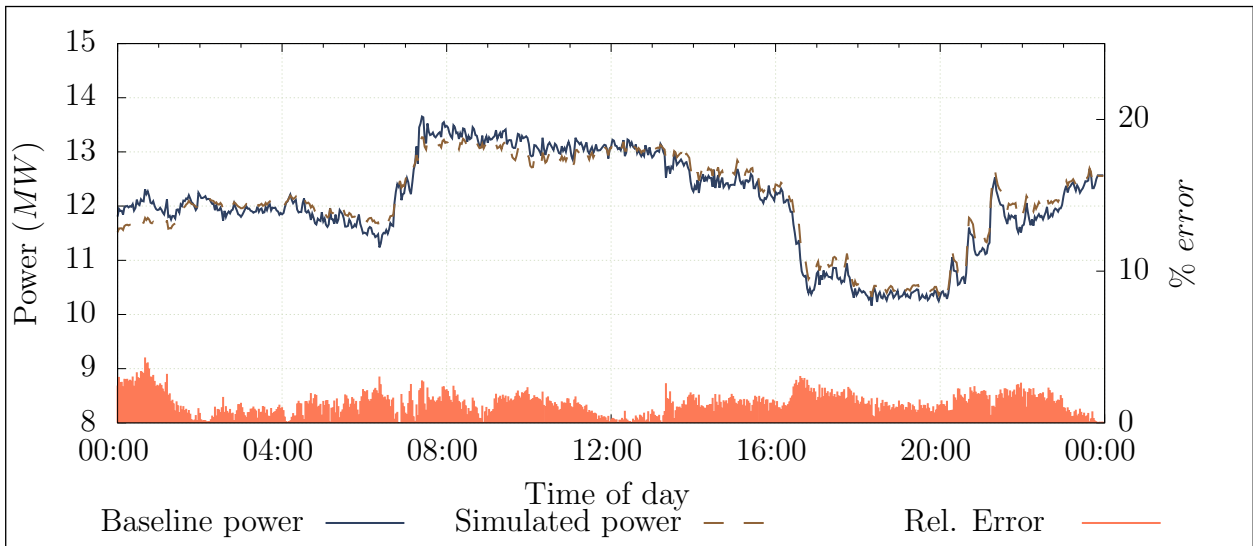

Figure 4.10: Simulated power compared to the actual measurement

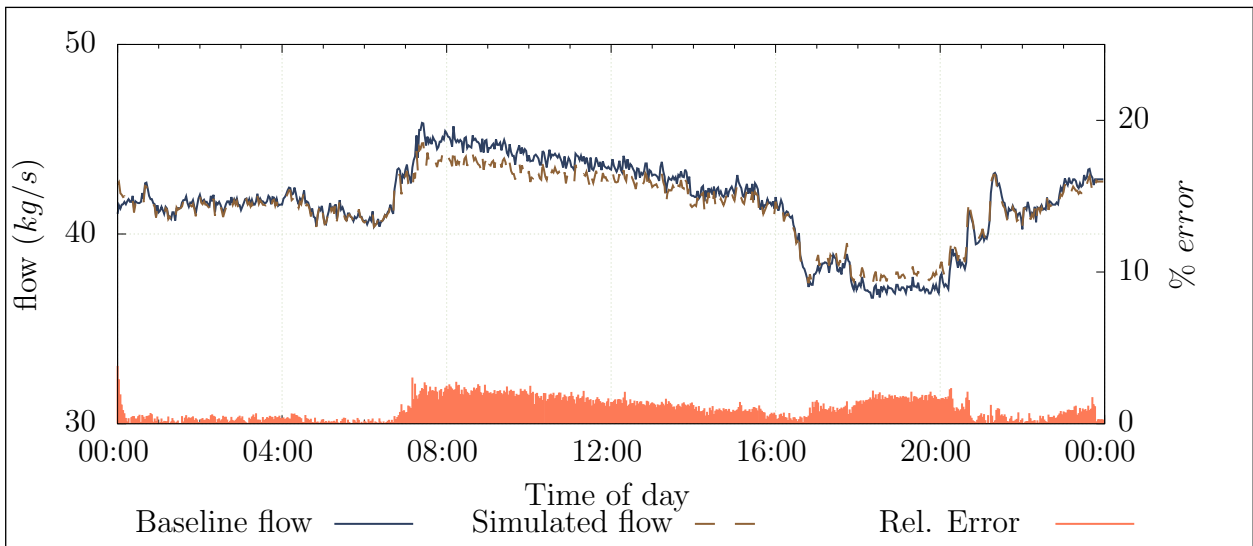

Figure 4.11: Simulated flow compared to the actual measurement

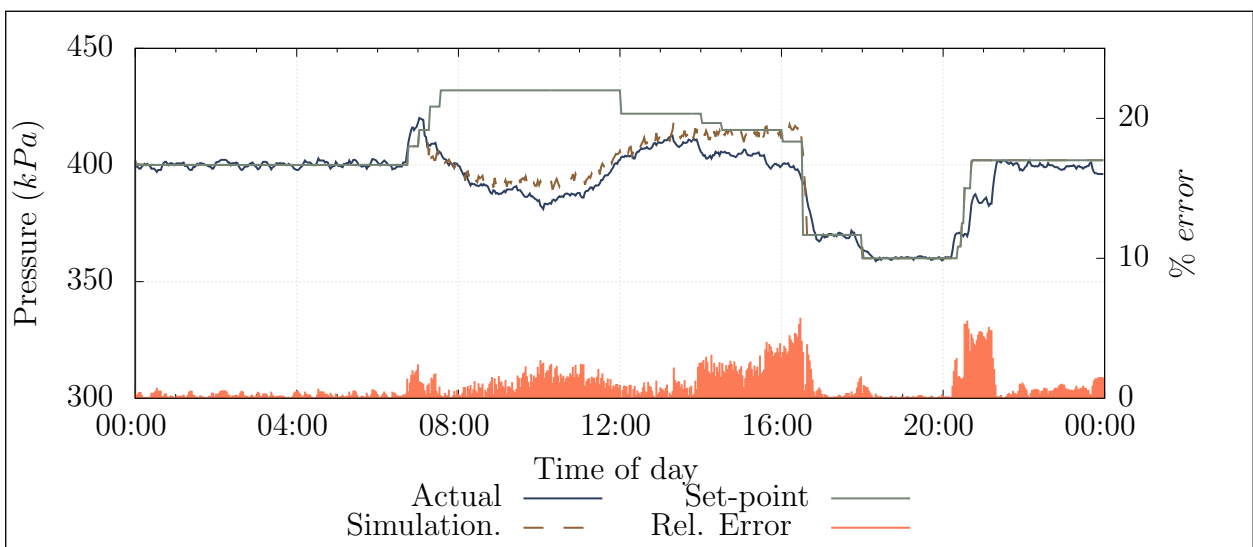

Figure 4.12: Simulated pressure compared to the actual measurement and set-points

Once the power and flow parameters were verified to be within an acceptable error limit, the actual pressure set-point profile was imported to the compressor controllers. The simulated outlet pressure was then compared to the actual measured pressure and set-point. This comparison is shown in Figure 4.12. The error of the compressor outlet pressure was acceptable at 0.98%. The measured flows for all measured subcomponents were independently verified to ensure system accuracy. A comparison between simulation outputs and physical measurements is shown in Table III.3 (Appendix III).

Table 4.5: Verification of simulation model

Verification method	Result	Err%
Total Flow		
Mean residual difference	0.22 <i>kg/s</i>	0.53%
MAE	0.43 <i>kg/s</i> error	1.02%
Coefficient of determination	$r^2 = 0.99$	-
Total power		
Mean residual difference	0.05 <i>MW</i>	0.39%
MAE	0.16 <i>MW</i> error	1.36%
Coefficient of determination	$r^2 = 0.91$	-
Compressor outlet pressure		
Mean residual difference	2.79 <i>kPa</i>	0.71%
MAE	3.85 <i>kPa</i> error	0.98%
Coefficient of determination	$r^2 = 0.890$	-

4.3.3 Scenario 1: Refuge bay optimisation

After an underground investigation, unnecessary refuge bay leaks were identified as a significant inefficiency that can be reduced. A test on a single mining level was performed to measure the potential flow saving by reducing refuge bay leaks. The test showed that the reduction of refuge bay leaks by closing the valves would lead to an average air saving of 0.05 *kg/s* per refuge bay at normal operational pressures. This measurement was conservative, as it was not possible to close all the refuge bays on the level for the test.

Due to the size of the mine, extending these tests to include the rest of the mining sections was not practical. Hence, the benefits of an intervention on the entire mine could not be determined accurately from practical tests. By using simulation, the typical operation could be accurately compared with the intervention scenario to quantify the potential financial and

operational benefits throughout a given period.

The simulation model boundaries were updated to include refuge bay leaks on each level. For each refuge chamber, an air leak was added to the model by utilising ‘per level layouts’ indicating locations of refuge bays. These leaks were modelled as flow demands, using the data from the initial refuge bay tests. The overall mass flow of the system was maintained to ensure model accuracy.

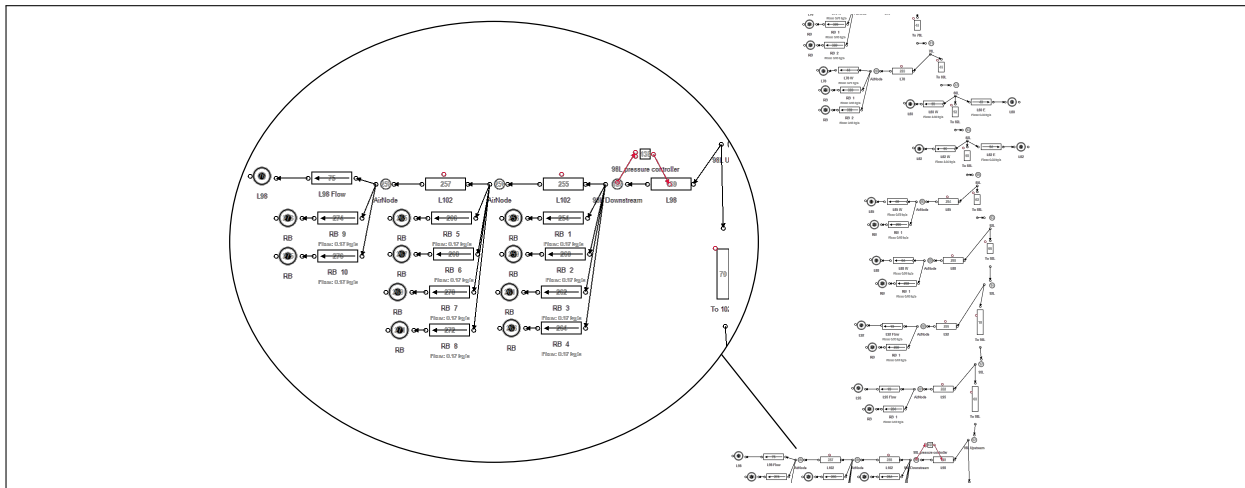

Figure 4.13: Addition of the refuge bay flow demands in the simulation model

By adding the flow components in the same location in the actual network, the pressure in each chamber could be correctly modelled (see simulation model schematic in Figure 4.13). The updated simulation was re-checked with actual data from the network. This model was then used as a baseline to quantify savings for the scenario.

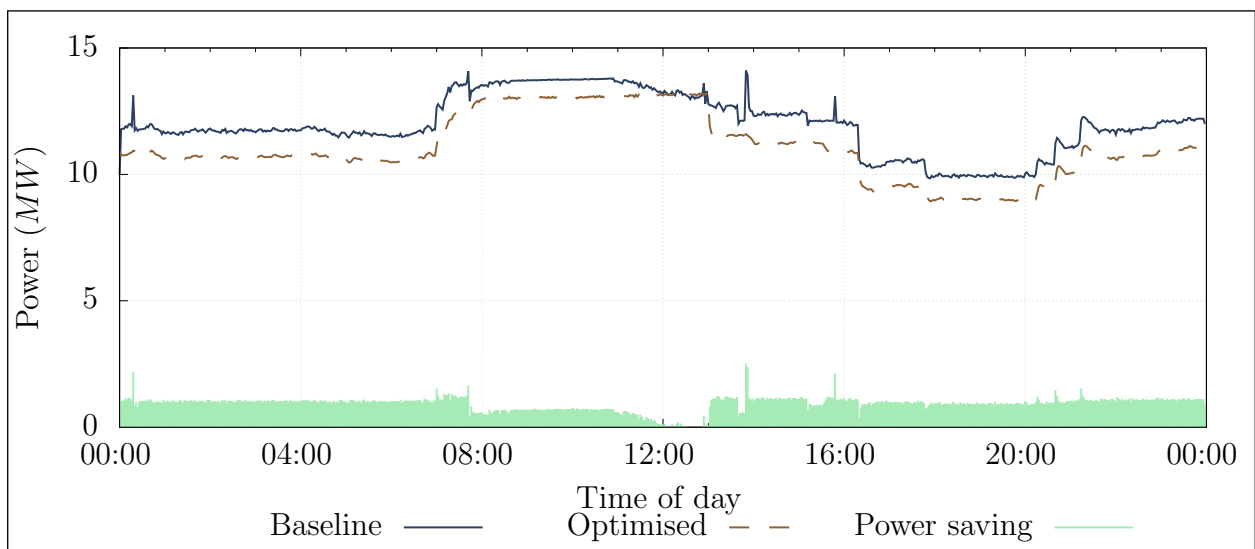

Figure 4.14: Baseline system power compared to system power when refuge bay leaks were reduced

The optimised scenario was recreated by setting the refuge bay flow components to 0 kg/s . The simulation was performed and the output data was compared to the baseline. Figure 4.14 shows the baseline power compared to the optimised scenario. The comparison revealed a potential 0.92 MW improvement in Energy Efficiency (EE) through the optimisation of refuge bay leaks. The optimised scenario would lead to R5.13m in annual energy cost savings for the mine.

An additional pressure benefit was identified during the drilling shift, as shown in Figure 4.15. The reduced flow leads to an average pressure increase of about 15 kPa during the drilling period, which could lead to a general improvement in drilling efficiency and potentially increase the rate of production. Such improvement may well have a greater benefit to the mine than the intended energy cost savings.

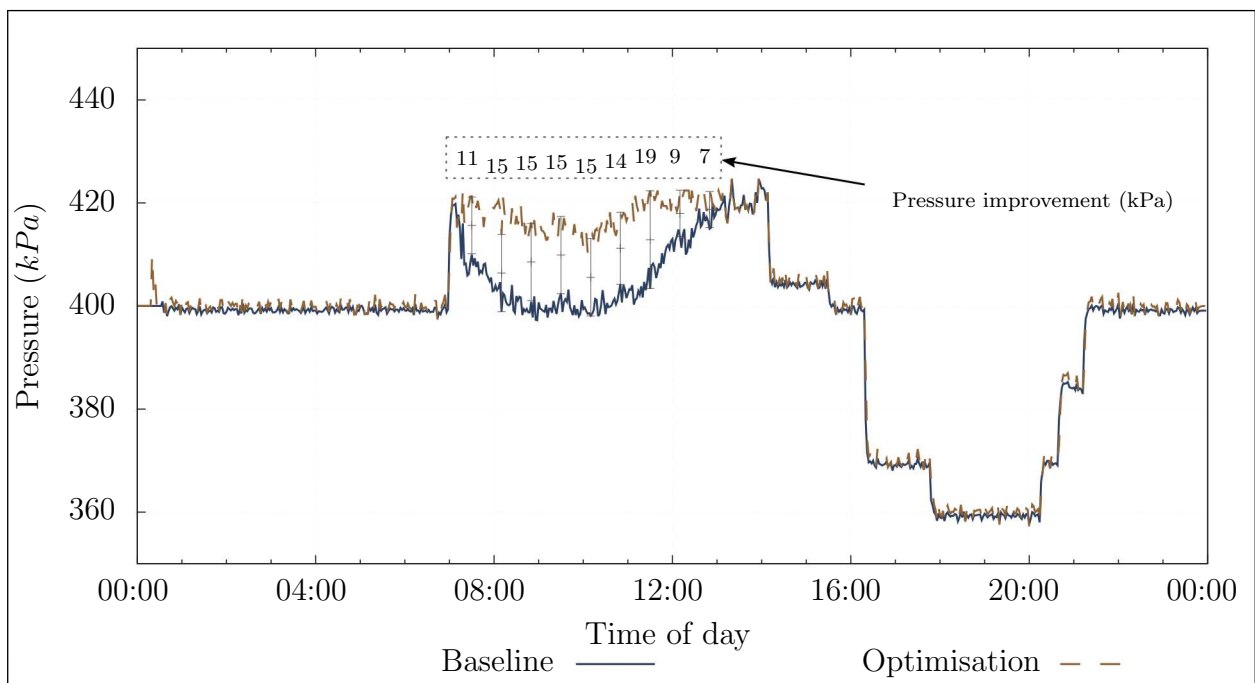

Figure 4.15: Baseline system pressure relative to system pressure when refuge bay leaks were reduced

4.3.4 Scenario 2: Closing off levels and inactive work areas

Scenario background

The largest impact on energy costs can be achieved during the energy high-demand periods. At mine B, blasting coincided with the evening energy demand peak. Typically, the air requirement during this period was lowered. However, due to compressed air misuse, leaks and open valves, significant amounts of air were still used during this time. Reducing pressure to areas during these times could well lead to a major power and cost saving.

Closing off valves at inactive work areas and reducing station pressure were identified as two further strategies to reduce airflow during the evening peak time. The station could not be closed completely, as some services required the air supply at all times.

Simulations were performed to identify the most suitable strategy and to quantify the effect of each on a single mining level. The level was modelled to include all the main leaks, refuge bays and drilling sections.

Underground investigation

105 Level was the most active production level at Mine B. An investigation was therefore performed to identify all the air users, leaks and inefficiencies at this level. A walkthrough manual inspection of the level was performed. Air users, leaks and inefficiencies were identified, quantified and mapped (see the resultant schematic in Appendix IV). The results were then used to develop a detailed model of the level in PTB.

A schematic representation of the simulation process of the level appears in Figure 4.16. This model was used to simulate various scenarios for station and working area air optimisation. When compared to the baseline, the effect of each scenario for a single mining level could be determined. The results could then be used to estimate the benefit for a generalised control philosophy applied to all active mining levels.

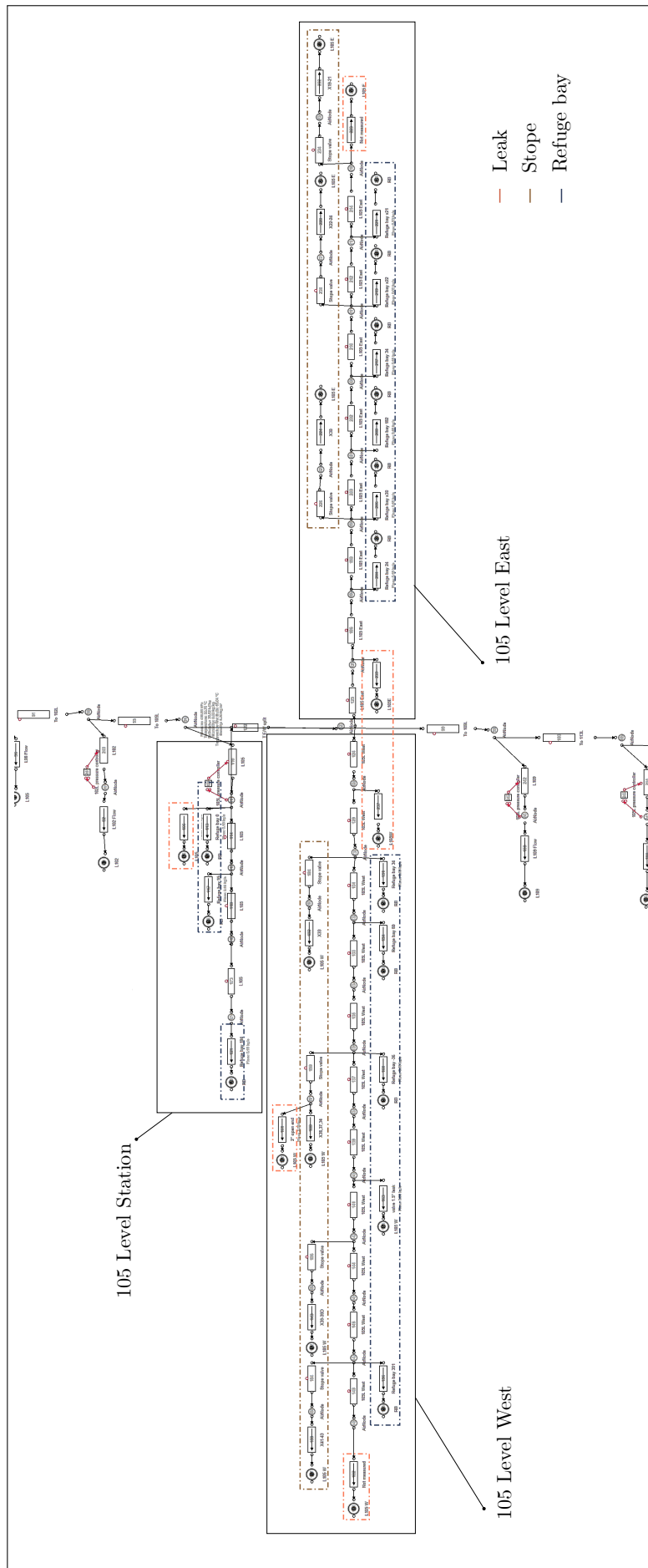

Figure 4.16: Underground level simulation layout

Simulated results

Station control, in-stope control and a combination of these were all simulated for 105 Level. Station control implies control of the pressure at the station of the level. In-stope control is control of the airflow to the mining section during certain periods. Figure 4.17 shows the effect that the various interventions have on the flow for 105L compared to the baseline.

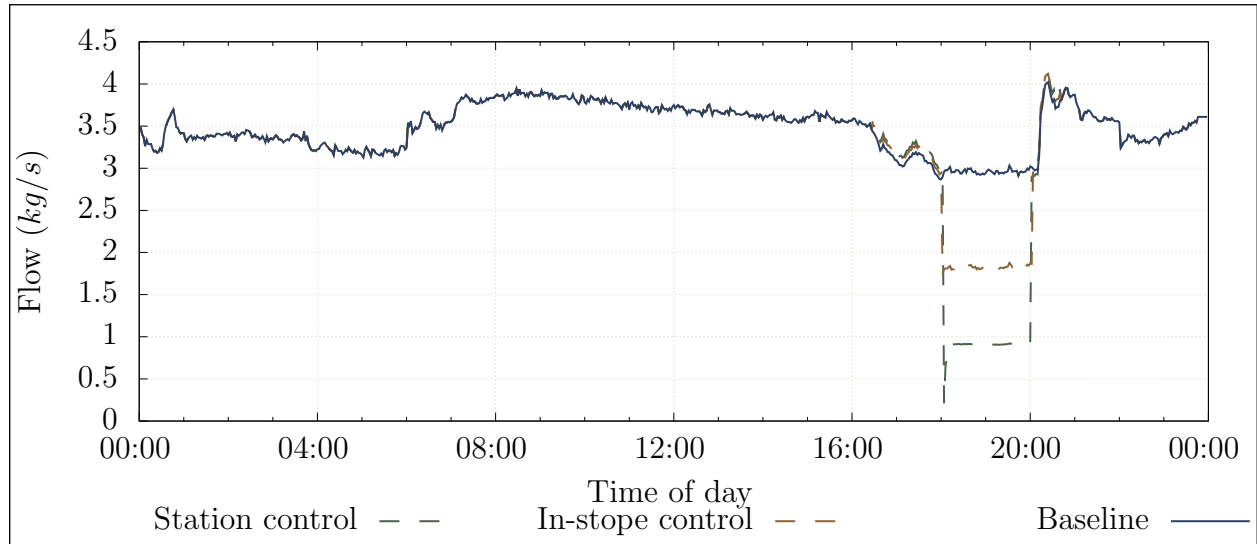

Figure 4.17: Flow reduction during blasting period for 105 Level

Station control had the largest impact on the flow usage for the level. This result reflects the power reduction achieved by each intervention as shown in Figure 4.18. The impact was 0.4 and 0.7 MW for the stope and station interventions respectively.

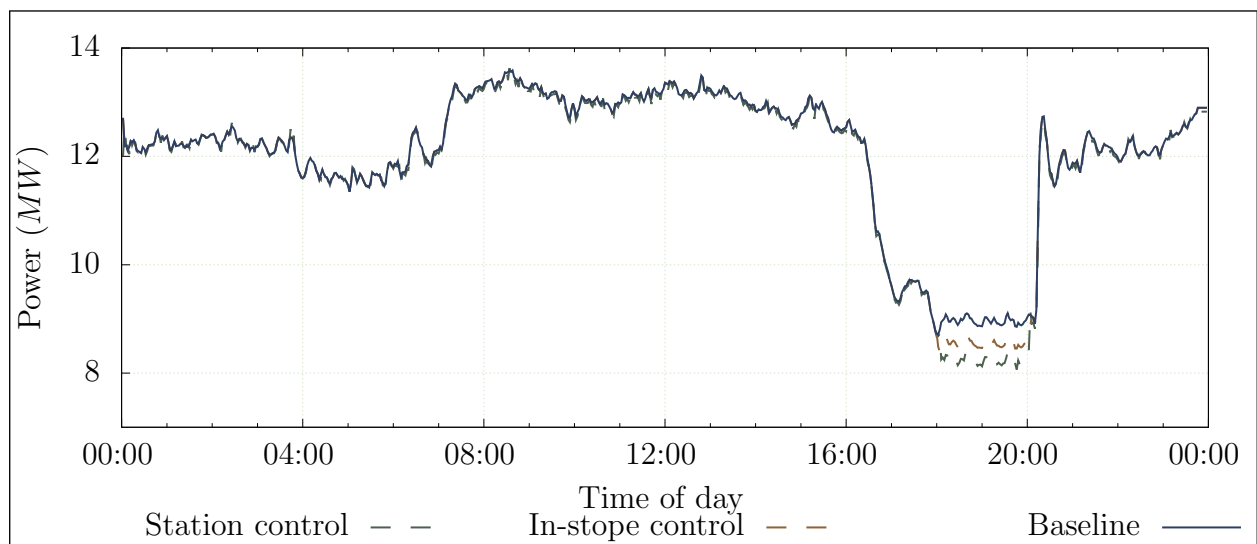

Figure 4.18: Comparing simulated flow interventions on 105 Level

A simulation was done to estimate the potential savings of extending the evening station control to other levels. The flow demands for levels 95 to 115 were updated to match the flow saving achieved in the 105 Level simulation. The savings obtained in generalised station

control simulation was 2.0 MW PC, as shown in Figure 4.19. It was calculated that this would lead to an annual energy cost saving of R2.5m.

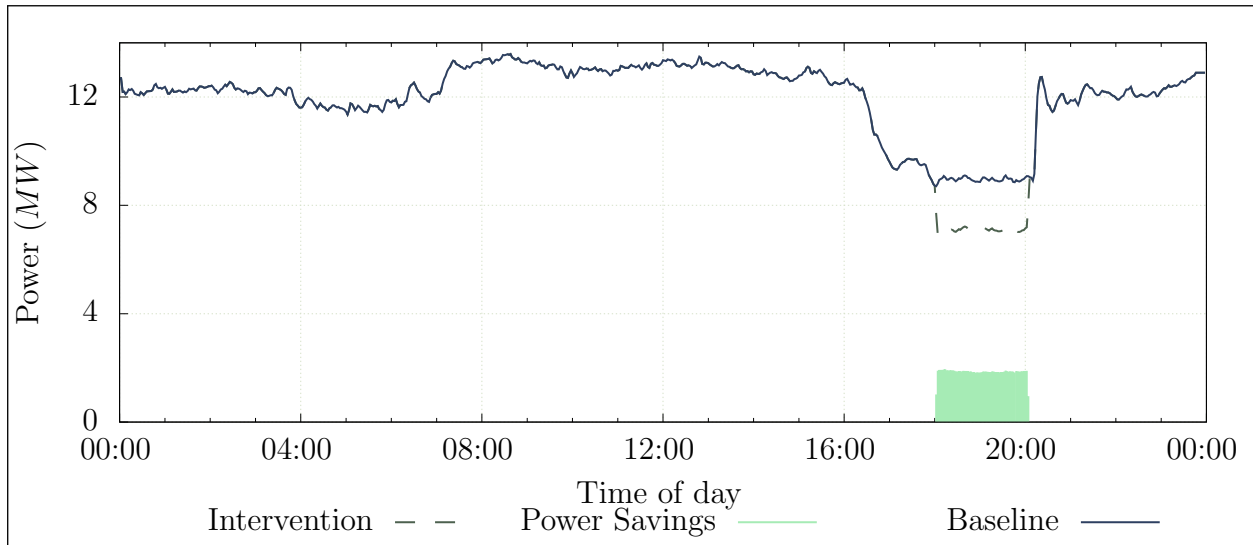

Figure 4.19: Energy saving achieved by general peak time station control

4.3.5 Comparison of interventions

The interventions were subsequently compared to give feedback to the mine. The refuge bay intervention was recommended as it would achieve the highest energy cost saving. These results were used to produce a report that was sent to the responsible personnel at Mine B.

Table 4.6: Comparison of the simulated scenarios

Scenario	Power saving	Cost saving (per year)	Additional benefit
Scenario 1			
Refuge bay leakage reduction	0.92 MW EE	R5.17m	Increase in drilling pressure
Scenario 2			
105 Level peak time in-Stope control	0.4 MW PC	R0.3m	-
105 Level peak time Station control	0.7 MW PC	R2.5m	-
General peak time Station control	2.0 MW PC	R2.5m	-

Validation of the simulated scenarios is not available for Case Study 2, as physical implementation or tests of the scenarios have not yet been performed for this study.

4.3.6 Summary

A second case study was performed on a mine compressed air network to gather data and identify potential interventions. This investigation included underground spot checks and measurements.

A simulation model was developed to test scenarios. Two scenarios (refuge bay optimisations and per level flow optimisations) were simulated. The simulated interventions showed an EE saving of up to 0.92 *MW*, which would result in an annual cost saving of R5.17m with an additional pressure improvement for Scenario 1. The results for Scenario 2 showed a PC impact of up to 2 *MW* with an annual energy cost saving of R2.5m. The results of the simulations were reported to the mine.

4.4 Case Study 3: Periodic simulation analysis

4.4.1 Preamble

Periodic updating of the inputs of a simulation could be used to verify the accuracy of the compressed air model. If the precision of simulation outputs remains within the set constraints for subsequent days, this would indicate that the model was correctly calibrated and up to date.

Additionally, this process could be used to identify significant operational changes that occur within the system. The operational changes would cause the simulation outputs to differ from the actual measured parameters. This information can be used to make improvements to the system.

A daily periodic simulation analysis was developed for the periods between 2016/11/01 and 2016/11/30, using the periodic simulation methodology discussed in Chapter 3. The simulation model that was developed in Case Study 2 was used for the analysis. The simulation received the following data inputs, as shown in Table 4.7.

Table 4.7: Data inputs and outputs for the simulation

Inputs	Outputs
Ambient air conditions	Compressor power
Measured flows	Flows
Compressor schedules	Pressures

4.4.2 Results

The simulation was triggered for 24-hour periods. For each period, the data inputs shown in Table 4.7 were imported into the model, the simulation was processed, and the outputs were compared with the real system parameters. No human interference in the model to calibrate or modify the model was performed or allowed. Figure 4.20 shows the average daily accuracy of the simulated total system power, flow and the shaft pressure per 24-hour period.

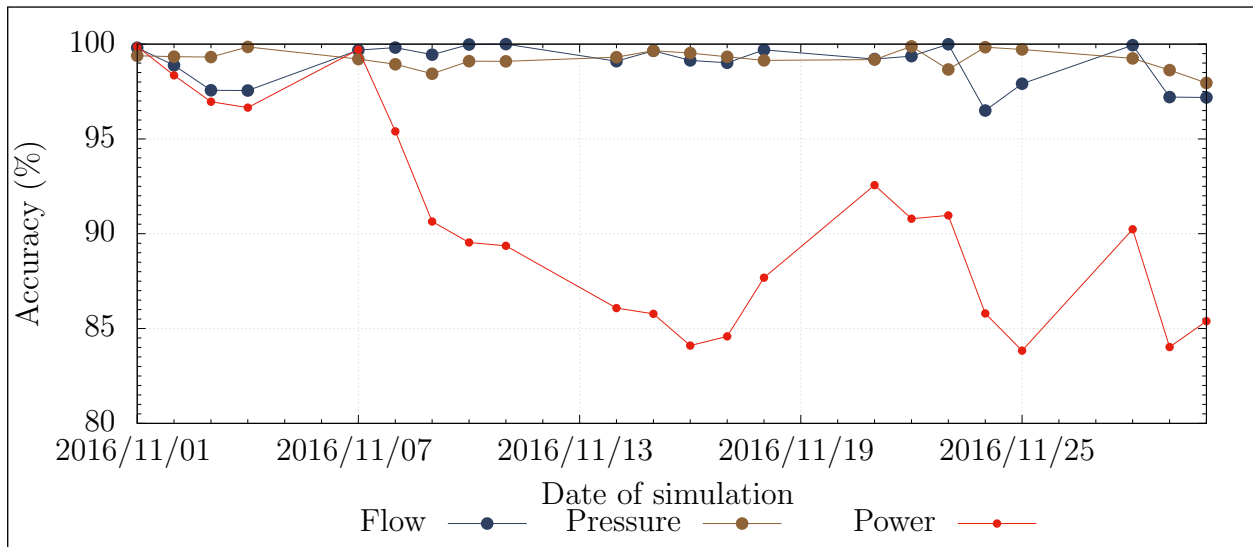

Figure 4.20: Flow, pressure and power error percentages for daily periodic simulations over a month

The process parameters of the simulation were accurate within 5% for the duration of the periodic simulation. However, from 2016/11/07, the accuracy of the simulated power dropped by between 10 and 15%. The average daily power of the system up to that point was approximately 12.5 MW. A 15% simulation error then related to 1.9 MW difference between simulated and actual values. This error suggested a major shift in operation of the system.

An analysis was done to try to determine the source of the discrepancy. From the data, it was found that the simulated power for Compressor 1 was the source of the difference. Checking the actual power measurement for Compressor 1 showed almost a 2 MW drop in power compared to the compressor's output in the initial period. At the same time, the amount of specific power lowered. This drop in specific power is illustrated in Figure 4.21, which shows the average daily power for Compressor 1 (blue), compared to the specific power (yellow).

Because a 2 MW shift in power was not likely, the results probably indicate that there was a fault in the power metering starting from 2016/11/07. A measurement error explains the perceived increase in efficiency over the same period, as less power was being measured than was actually being used. In this situation, the simulated power measurement is a more

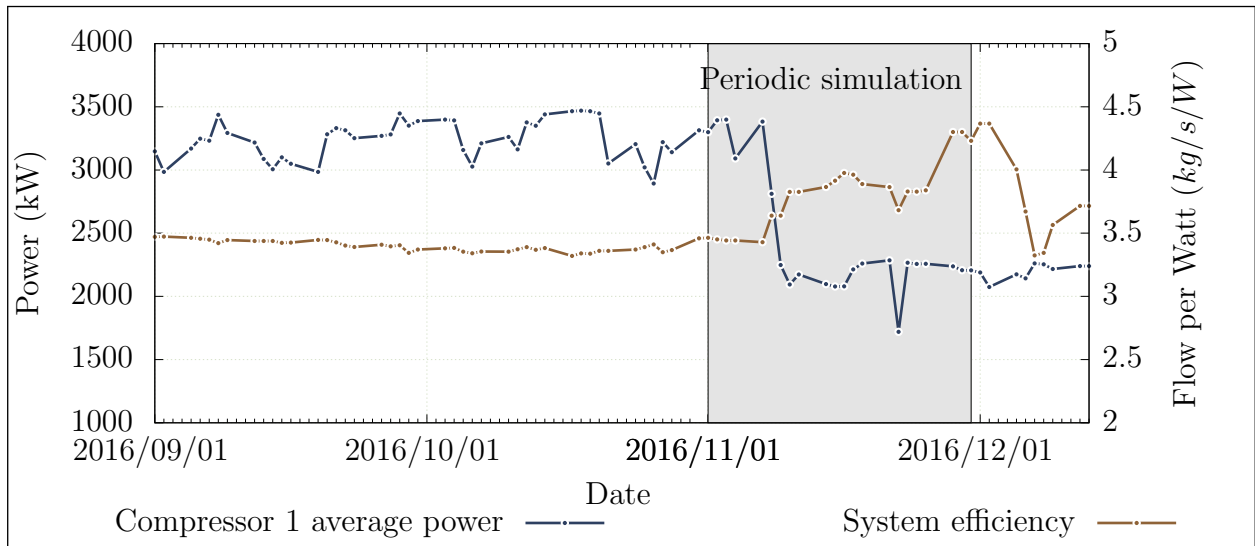

Figure 4.21: Supply efficiency and Compressor 1's average power output over the time of the periodic analysis

accurate metric for Compressor 1's power over this period.

4.4.3 Validation

Data from independent power meters was compared to the measurements used in the analysis. Figure 4.22 compares the measured power from the two data sources. By comparing the compressor power data and the independent data, it is clear that there was an error in measurement as suggested by the periodic simulation analysis.

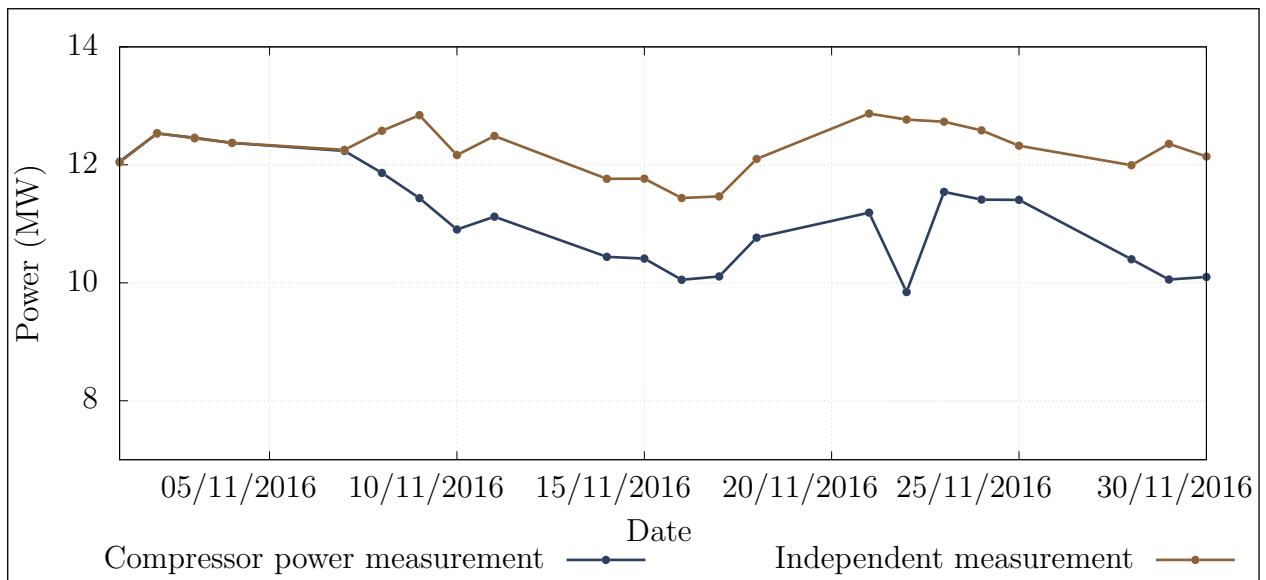

Figure 4.22: Comparison using alternative power sources

4.4.4 Summary

An investigation into periodic or repeated simulation was performed. Using the simulation model that was developed for Mine B, the periodic simulation methodology was implemented for a month. The results indicated that the model's process parameters (except for total power) were accurate for the duration of the analysis.

A shift in output power for a compressor was identified as a result of an error in power measurement. Further analysis is recommended to determine how long a simulation model could be expected to remain valid before re-calibration is required.

4.5 Potential benefit for South African mines

There are approximately 75 operational gold and Platinum Group Metal (PGM) mines in South Africa, as illustrated in Figure 4.23^{1,2}. While some mines use hydraulic systems, most mines use compressed air for underground processes. By applying the compressed air simulation methodology in this study, the mines concerned could collectively achieve significant energy and cost savings for the industry.

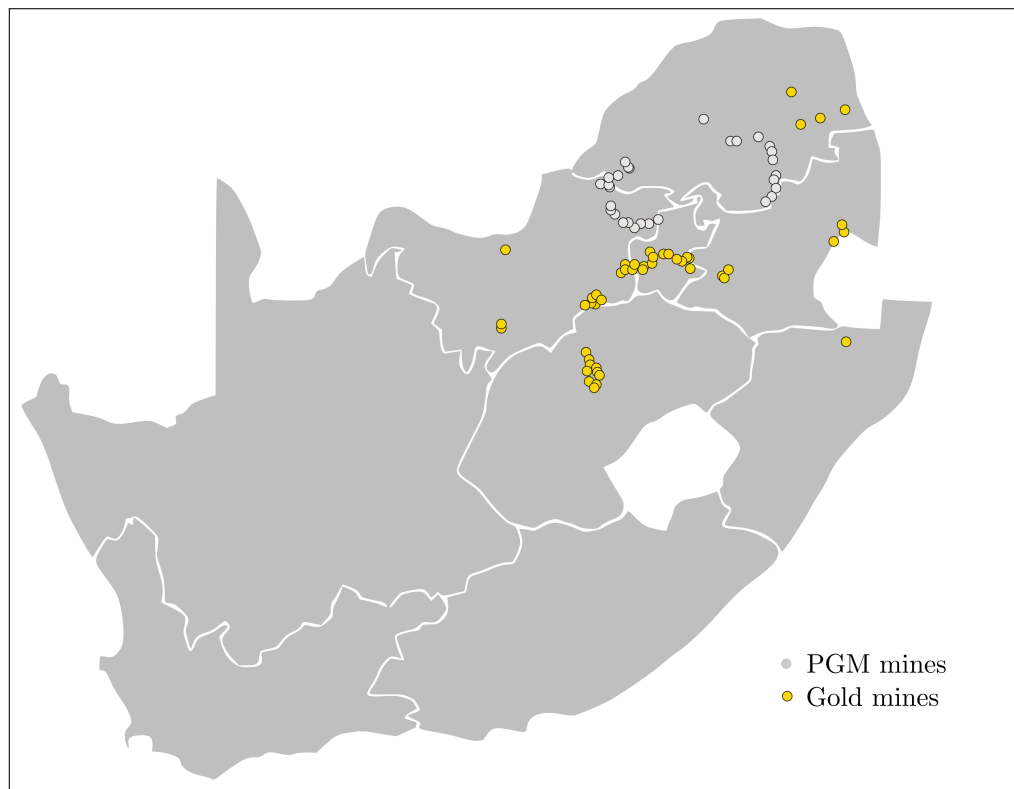

Figure 4.23: Gold and PGM mines in South Africa^{1,2}

¹ Chamber of Mines, [Online] <http://www.chamberofmines.org.za/sa-mining/gold>, [Accessed 16-06-2017]

² Chamber of Mines, [Online] <http://www.chamberofmines.org.za/sa-mining/platinum>, [Accessed 16-06-2017]

In this study, the simulated interventions resulted in savings of (on average) 0.69 *MW* EE or 1.025 *MW* PC, assuming the following:

- There are 75 operational mines
- Similar savings could be identified for compressed at 60% of the operational mines

A potential energy saving of approximately 30 *MW* EE or 45 *MW* PC could be achieved. The combined cost saving for these interventions would amount to R240m per year.

4.6 Conclusion

Chapter 4 aimed to validate the methodology developed in Chapter 3. This validation was achieved through the implementation of two case studies at South African gold mines. A third case study was performed to analyse and validate the value of repeated/periodic simulation.

In Case Study 1, the compressed air network for a gold-mining complex consisting of three mining shafts was investigated. A simulation model was subsequently developed, and the accuracy was verified using typical operations obtained from historical data. Two scenarios were simulated, by optimising compressor set-points and reducing pressure during the evening energy peak.

The results showed that there was a potential P.C. power reduction of 0.46 and 1.0 *MW* respectively. The reduction in power during the energy peak times could lead to a potential cost reduction of up to R0.91m. The result was validated using results of actual tests on the system.

In Case Study 2, the same procedure was applied to another gold mine. This mine consisted of a main and sub-shaft. An investigation was made to gather data and identify potential interventions. The investigation included underground spot checks and measurements.

A simulation model was developed for the system and two scenarios were simulated using the developed model. The simulations showed an EE saving of up to 0.92 *MW* for Scenario 1 and a PC impact of up to 2 *MW* for Scenario 2. This intervention could lead to an energy cost saving of R5.17m for the mine. Additional pressure improvements were identified in Case Study 1 and the results were reported to the mine.

Case Study 3 was performed to validate the periodic or repeated simulation methodology. The results showed that the simulation model remained valid for consecutive days in the tested date range. Faulty power measurements were also identified from the results. Further analysis was recommended to determine how long a simulation model could remain valid before re-calibration was required.

Finally, the result of the large-scale implementation of compressed air simulation in South African gold and PGM mines was estimated. A conservative estimation showed that a potential power reduction of 50 MW EE or 75 MW PC could be obtained. This energy improvement would lead to a significant total energy cost saving of R400m per year.

CHAPTER 5

Conclusion

5.1 Preamble

Chapter 5 serves as the conclusion of this dissertation and it provides an overview of the complete dissertation. This overview summarises the work done in the preceding chapters and discusses the limitations of the study as well as recommendations for future work to be done in the field.

5.2 Dissertation overview

The South African mining sector is currently facing significant challenges that pose a risk to the profitability of the industry. A central challenge that faces the industry is that of rising operational costs. Energy costs constitute a significant portion of the cost increases as energy tariff increases have consistently exceeded inflation over the past ten years.

Compressed air systems do not only consume the largest portion of energy used in a mine, but they were also shown to be largely inefficient. It is therefore reasoned that the greatest energy impact can be achieved through interventions in respect of compressed air networks.

Energy interventions in mining compressed air systems have been performed in the past. However, compressed air simulation has not been used to its full potential. The specific effects of interventions imply minimal risk, by using new computer modelling and simulation tools for compressed air systems. This will lead to further energy and cost reductions as well as other potential improvements in the operation of a mine.

A review of background and literature was performed. The purpose of the review was to provide background on mining compressed air networks and to evaluate literature pertaining to compressed air energy interventions, as well as to simulation usage in the mining industry in general and compressed air systems in particular.

A methodology was developed for compressed air simulation, using the findings that emerged from the literature review. The method describes the simulation procedure in three steps, namely: investigate the system; develop a simulation model; and execute the simulation scenarios.

The simulation methodology was implemented with case studies that were performed on the compressed air systems of two different mines. A full system investigation was conducted in each study. From the data and information obtained from the investigation, simulation models were developed for both systems. The models were verified using measurement data

from the physical system and they were used to simulate various operational scenarios.

In Case Study 1, two scenarios were simulated. The results of the first scenario – reducing compressor set-points – showed a potential power reduction of 0.46 *MW* PC, which would result in a yearly energy cost saving of R0.37m. Scenario 2 – reducing underground control valve pressure – showed a potential power reduction of 1.0 *MW* PC, which would result in a yearly energy cost saving of R0.91m. The result of the simulation was validated by comparing it with the actual results of the test conducted on the physical system.

In Case Study 2, two scenarios were simulated. The first scenario looked at reducing refuge bay leaks. The results showed a potential energy efficiency improvement of 0.92 *MW*, which would result in an annual energy cost saving of R5.17m. A further pressure improvement of 15 *kPa* during the drilling time was identified. In Scenario 2, optimising peak-time demand through station and in-stope control was investigated. The results showed that a potential power reduction of up to 2.0 *MW* PC could be obtained. This optimisation would lead to energy cost saving of R0.91m per year.

In Case Study 3, repeated periodic simulations were analysed. The investigation aimed to check the validity of simulation models and to identify when major shifts in a compressed air system's operation occur. A faulty power meter was identified. However, based on the pressure and flow process parameters, the analysis showed that the model accurately represented the system over the period of repeated simulations.

Implementing the simulation methodology developed in this study in other gold and PGM mines' compressed air systems would bring about significant energy cost savings and operational improvements for the industry. It was estimated that up to a 30 *MW* energy efficiency improvement could be achieved. This increase in efficiency would lead to cost savings of up to R240m per year for the industry.

5.3 Recommendations for future studies

This study focused on operational improvements in compressed air systems as they offered the largest scope for energy improvement. However, an integrated simulation approach could also lead to significant operational improvements in other large industrial systems, such as ventilation and water reticulation.

Simulation model details, are dependent on system boundary selection as well as varying air properties. Since the current study did not investigate the actual effect of different boundary selections or differing input conditions with regard to simulation accuracy, there is scope for a sensitivity analysis to analyse the accuracy of simulations with different boundary choices.

A major limiting factor in integrated simulations of large systems is the availability of reliable data. A study that focuses on the value of instrumentation for simulation and system improvement identification is recommended. The study should investigate the availability of data in mining systems and the relation with energy operational improvement measures.

In Case Study 2, an additional pressure benefit was identified in one of the simulated scenarios. It is recommended that future studies investigate the financial impact of pressure improvements that may result from quicker/more efficient drilling. Finally, a future study should be performed to validate the simulation results achieved in Case Study 2. This can be achieved through practical tests executed on the physical system.

Bibliography

- [1] P. Neingo and T. Tholana, “Trends in productivity in the South African gold mining industry,” *Journal of the Southern African Institute of Mining and Metallurgy*, vol. 116, no. 3, pp. 283–290, 2016.
- [2] G. M. Mudd, “Global trends in gold mining: Towards quantifying environmental and resource sustainability,” *Resources Policy*, vol. 32, no. 1, pp. 42–56, 2007.
- [3] J. Müller and H. Frimmel, “Numerical analysis of historic gold production cycles and implications for future sub-cycles,” *The Open Geology Journal*, vol. 4, no. 1, pp. 29–34, 2010.
- [4] J. Vosloo, L. Liebenberg, and D. Velleman, “Case study: Energy savings for a deep-mine water reticulation system,” *Applied Energy*, vol. 92, pp. 328–335, 2012.
- [5] H. Le Roux, “Energy consumption reduction challenge,” *Mining Weekly, PO Box*, vol. 75316, p. 30, 2005.
- [6] J. Marais, “An integrated approach to optimise energy consumption of mine compressed air systems,” Ph.D. thesis, North-West University, 2012.
- [7] L. Padachi, G. Bolt, M. Kleingeld, J. Marais, and E. Mathews, “Energy efficiency through the integration of compressed air supply control with air network demand control,” in *Proceedings of the Industrial and Commercial Use of Energy Conference (ICUE)*. IEEE, 2009, pp. 77–80.
- [8] J. du Plessis and R. Pelzer, “Development of an intelligent control system for mine compressor systems,” in *Proceedings of the Industrial and Commercial Use of Energy Conference (ICUE)*. IEEE, 2011, pp. 59–63.
- [9] P. Fraser, “Saving energy by replacing compressed air with localized hydropower systems: a ‘half level’ model approach,” *Platinum in Transformation*, 2008.
- [10] J. Neale and P. Kamp, “Compressed air system best practice programmes: What needs to change to secure long-term energy savings for New Zealand?” *Energy Policy*, vol. 37, no. 9, pp. 3400–3408, 2009.

-
- [11] J. Marais and J. v. M Kleingeld, “Simplification of mine compressed air systems,” in *Proceedings of the Industrial and Commercial Use of Energy Conference (ICUE)*. IEEE, 2013, pp. 1–8.
- [12] L. B. N. Laboratory, *Improving Compressed Air System Performance: A Sourcebook for Industry*, 2nd ed. Washington DC: US Department of Energy, 2004.
- [13] A. van Tonder, “Sustaining compressed air DSM project savings using an air leakage management system,” Masters dissertation, North-West University, 2011.
- [14] J. Snyman, “Integrating various energy saving initiatives on compressed air systems of typical South African gold mines,” Masters dissertation, North-West University, 2010.
- [15] C. Kocsis, R. Hall, and S. Hardcastle, “The integration of mine simulation and ventilation simulation to develop a ‘life cycle’ mine ventilation system,” *Application of Computers and Operations Research in the Minerals Industries, South African Institute of Mining and Metallurgy*, pp. 223–230, 2003.
- [16] J. Banks, *Handbook of simulation: principles, methodology, advances, applications, and practice*, 1st ed. John Wiley & Sons, 1998, ch. 1, pp. 3–30.
- [17] C. Kriel, “Modernising underground compressed air DSM projects to reduce operating costs,” Masters dissertation, North-West University, 2014.
- [18] J. Bredenkamp, A. Schutte, and J. F. van Rensburg, “Challenges faced during implementation of a compressed air energy savings project on a gold mine,” in *Proceedings of the 12th Industrial and Commercial Use of Energy Conference (ICUE)*. IEEE, 2015.
- [19] P. Maré, J. Bredenkamp, and J. Marais, “Evaluating compressed air operational improvements on a deep-level mine through simulations,” in *Proceedings of the Industrial and Commercial Use of Energy Conference (ICUE)*. IEEE, 2017.
- [20] S. Fouché, “Improving efficiency of a mine compressed air system,” Masters dissertation, North-West University, 2016.
- [21] W. Booyesen, “Reducing energy on RSA mines through optimised compressor control,” Masters dissertation, North-West University, 2010.
- [22] M. Yang, “Air compressor efficiency in a vietnamese enterprise,” *Energy Policy*, vol. 37, no. 6, pp. 2327–2337, 2009.

-
- [23] A. van Jaarsveld and S. Ebben, “Development and implementation of an electrically powered stope rockdrill for Tau Tona mine,” in *SAIMM Narrow Vein and Reef Conference, Sun City, South Africa*, 2008.
- [24] D. Brake and G. Bates, “Criteria for the design of emergency refuge stations for an underground metal mine,” in *AusIMM Proceedings*, vol. 304, no. 2. The Australian Institute of Mining and Metallurgy, 1999, pp. 1–8.
- [25] F. Schroeder, “Energy efficiency opportunities in mine compressed air systems,” Masters dissertation, North-West University, 2009.
- [26] M. Kleingeld and J. Marais, “A high level strategy plan for reducing a mine group’s dependence on compressed air,” in *Proceedings of the Industrial and Commercial Use of Energy Conference (ICUE)*. IEEE, 2010.
- [27] J. Marais and M. Kleingeld, “An expert control system to achieve energy savings on mine compressed air systems,” in *Proceedings of the Industrial and Commercial Use of Energy Conference (ICUE)*. IEEE, 2010.
- [28] W. Booysen, M. Kleingeld, and J. F. van Rensburg, “Optimising compressor control strategies for maximum energy savings,” in *Proceedings of the Industrial and Commercial Use of Energy Conference (ICUE)*. IEEE, 2009, pp. 10–12.
- [29] J. Bredenkamp, “Reconfiguring mining compressed air networks for cost savings,” Masters dissertation, North-West University, 2013.
- [30] R. Saidur, N. Rahim, and M. Hasanuzzaman, “A review on compressed-air energy use and energy savings,” *Renewable and Sustainable Energy Reviews*, vol. 14, no. 4, pp. 1135–1153, 2010.
- [31] A. J. M. van Tonder, “Sustaining compressed air DSM project savings using an air leakage management system,” in *Proceedings of the Industrial and Commercial Use of Energy Conference (ICUE)*. IEEE, 2011, pp. 133–137.
- [32] B. Pascoe, “Improving mine compressed air network efficiency through demand and supply control,” Masters dissertation, North-West University, 2016.
- [33] J. Marais, M. Kleingeld, and R. Pelzer, “Increased energy savings through a compressed air leakage documentation system,” in *Proceedings of the Industrial and Commercial Use of Energy Conference (ICUE)*. IEEE, 2009.

-
- [34] H. Nesor, R. Pelzer, and M. Kleingeld, “Energy savings through the automatic control of underground air demand,” in *Proceedings of the Industrial and Commercial Use of Energy Conference (ICUE)*. IEEE, 2008.
- [35] S. Bester, D. le Roux, and D. Adams, “The effect of compressed air pressure on mining production and energy demand,” in *Proceedings of the Industrial and Commercial Use of Energy Conference (ICUE)*. IEEE, 2013, pp. 1–4.
- [36] C. Cilliers, “Benchmarking electricity use of deep-level mines,” Ph.D. thesis, North-West University, 2015.
- [37] W. van Niekerk, M. Kleingeld, and W. Booysen, “The value of simulation models when implementing mine DSM projects,” in *Proceedings of the Industrial and Commercial Use of Energy Conference (ICUE)*. IEEE, 2013, pp. 1–4.
- [38] W. van Niekerk, “The value of simulation models for mine DSM projects,” Masters dissertation, North-West University, 2012.
- [39] A. Holman, “Benefits of improved performance monitoring of mine cooling systems,” Masters dissertation, North-West University, 2014.
- [40] P. Maré, “Novel simulations for energy management of mine cooling systems,” Ph.D. thesis, North-West University, 2016.
- [41] W. Bouwer, “Designing a dynamic thermal and energy system simulation scheme for cross industry applications,” Ph.D. thesis, North-West University, 2004.
- [42] Y. Hollander and R. Liu, “Estimation of the distribution of travel times by repeated simulation,” *Transportation Research Part C*, vol. 16, pp. 212–231, 2008.
- [43] S. W. van Heerden, R. Pelzer, and J. Marais, “Developing a dynamic control system for mine compressed air networks,” in *Proceedings of the Industrial and Commercial Use of Energy Conference (ICUE)*. IEEE, 2014, pp. 1–8.
- [44] A. van Tonder, “Automation of compressor networks through a dynamic control system,” Ph.D. thesis, North-West University, 2014.
- [45] H. Sarin *et al.*, “Comparing time histories for validation of simulation models: error measures and metrics,” *Journal of dynamic systems, measurement, and control*, vol. 132, no. 6, p. 061401, 2010.

-
- [46] Y.-j. Xu, S.-j. Zhang, and Y.-h. Xiao, “Modeling the dynamic simulation and control of a single effect LiBr–H₂O absorption chiller,” *Applied Thermal Engineering*, vol. 107, pp. 1183–1191, 2016.
- [47] J. Kurnia, A. P. Sasmito, and A. S. Mujumdar, “Simulation of a novel intermittent ventilation system for underground mines,” *Tunnelling and Underground Space Technology*, vol. 42, pp. 206–215, 2014.
- [48] J. C. Kurnia, A. P. Sasmito, and A. S. Mujumdar, “Dust dispersion and management in underground mining faces,” *International Journal of Mining Science and Technology*, vol. 24, no. 1, pp. 39–44, 2014.
- [49] D. C. Arndt, “Integrated dynamic simulation of large thermal systems,” Ph.D. thesis, University of Pretoria, 2000.
- [50] M. Sprague and T. Geers, “Objective error measure for the comparison of calculated and measured transient response histories,” *Shock and Vibration Bulletin*, pp. 99–107, 1984.
- [51] M. Sprague and T. Geers, “Spectral element method for modelling cavitation in transient fluid-structure interaction,” *International Journal for Numerical Methods in Engineering*, pp. 2467—2499, 2004.
- [52] D. Russell, “Error measures for comparing transient data: Part I, development of a comprehensive error measure,” *Proceedings of the 68th Shock and Vibration Symposium*, pp. 175–184, 1997.
- [53] D. Russell, “Error measures for comparing transient data: Part II, error measures case study,” *Proceedings of the 68th Shock and Vibration Symposium*, pp. 212–231, 1997.
- [54] C. J. Willmott and K. Matsuura, “Advantages of the mean absolute error (MAE) over the root mean square error (RMSE) in assessing average model performance,” *Climate research*, vol. 30, no. 1, pp. 79–82, 2005.
- [55] S. Dominic and Maier, “Dynamic modeling and simulation of compressor trains for an air separation unit,” *IFAC Proceedings Volumes*, vol. 47, no. 3, pp. 432–437, 2014.
- [56] G. E. du Plessis, D. C. Arndt, and E. H. Mathews, “The development and integrated simulation of a variable water flow energy saving strategy for deep-mine cooling systems,” *Sustainable Energy Technologies and Assessments*, vol. 10, pp. 71–78, 2015.
- [57] P. Peach, “Optimising deep-level mine refrigeration control for sustainable cost savings,” Masters dissertation, North-West University, 2016.

-
- [58] S. Mousavi, S. Kara, and B. Kornfeld, “Energy efficiency of compressed air systems,” *Procedia CIRP*, vol. 15, pp. 313–318, 2014.
- [59] J. Zahlan and S. Asfour, “A multi-objective approach for determining optimal air compressor location in a manufacturing facility,” *Journal of Manufacturing Systems*, vol. 35, pp. 176–190, 2015.
- [60] A. Gous, W. Booyesen, and W. Hamer, “Data quality evaluation for measurement and verification processes,” in *Proceedings of the Industrial and Commercial Use of Energy Conference (ICUE)*. IEEE, 2016, pp. 9–15.
- [61] L. Meijsen, J. van Rensburg, and W. Booyesen, “Verification procedures to ensure consistent energy metering,” in *Proceedings of the Industrial and Commercial Use of Energy Conference (ICUE)*. IEEE, 2015, pp. 138–146.
- [62] S. van Niekerk, “Quantification of energy consumption and production drivers in steel manufacturing plants,” Masters dissertation, North-West University, 2016.
- [63] H. J. van Rensburg, “Structuring mining data for RSA section 12l EE tax incentives,” Masters dissertation, North-West University, 2016.
- [64] G. Heyns, “Challenges faced during implementation of a compressed air energy savings project on a gold mine,” Masters dissertation, North-West University, 2014.
- [65] M. H. P. Van Niekerk, S. van Heerden, and J. van Rensburg, “The implementation of a dynamic air compressor selector system in mines,” in *Proceedings of the Industrial and Commercial Use of Energy Conference (ICUE)*. IEEE, 2015, pp. 129–132.

APPENDIX I

Simulation process flow schematics

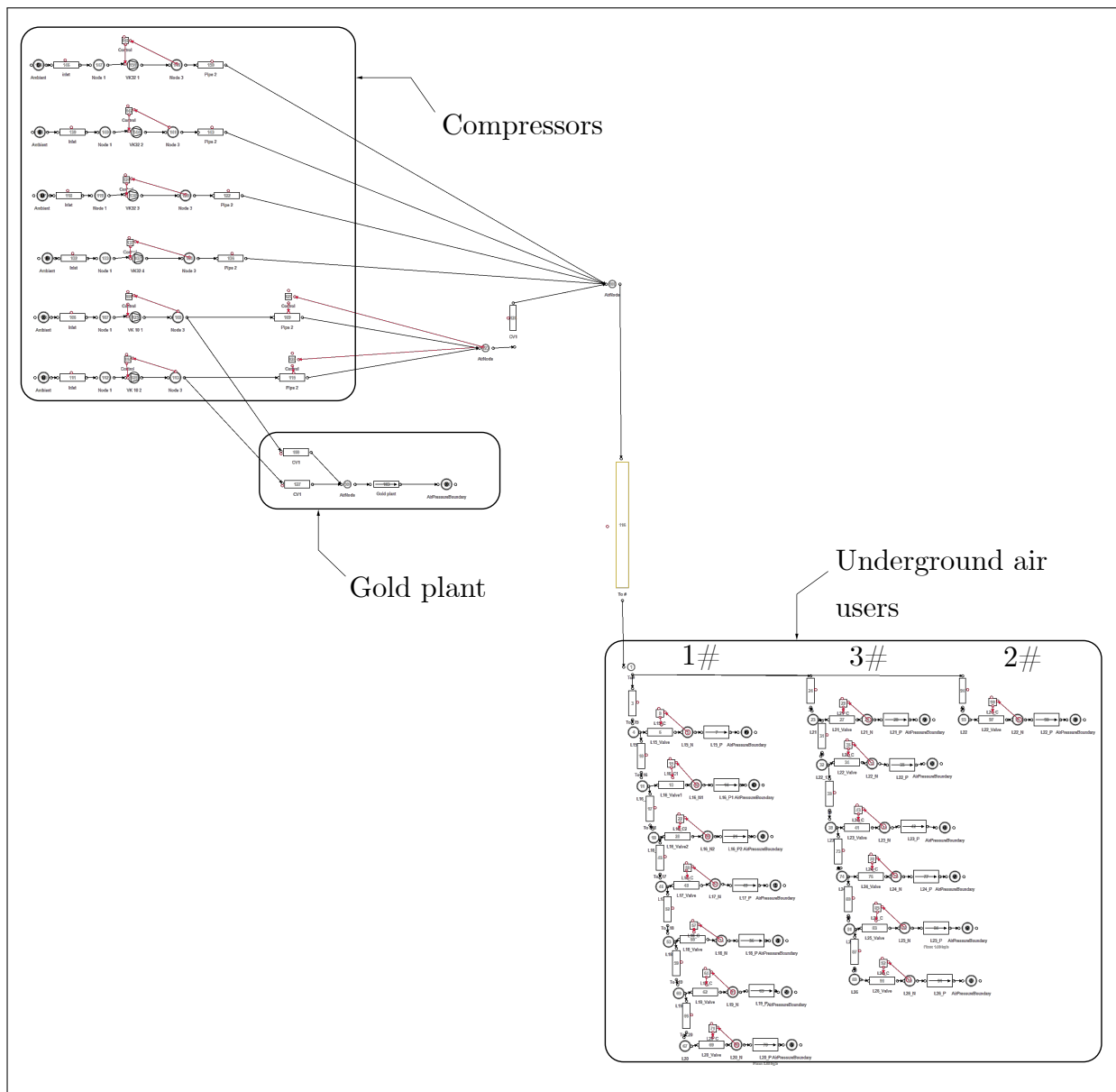

Figure I.1: Schematic representation of Mine A's compressed air simulation

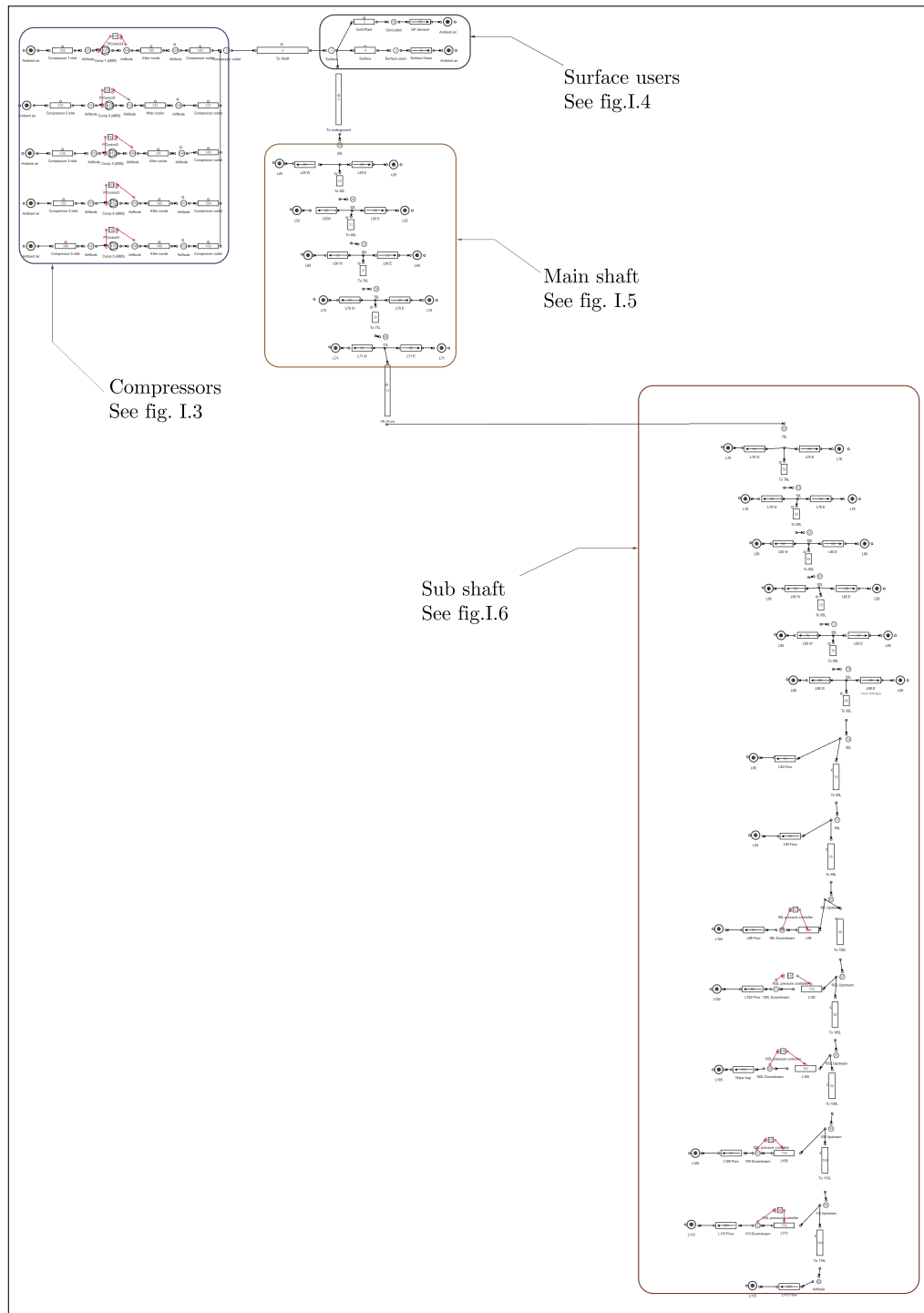

Figure I.2: Schematic representation of Mine B's compressed air simulation

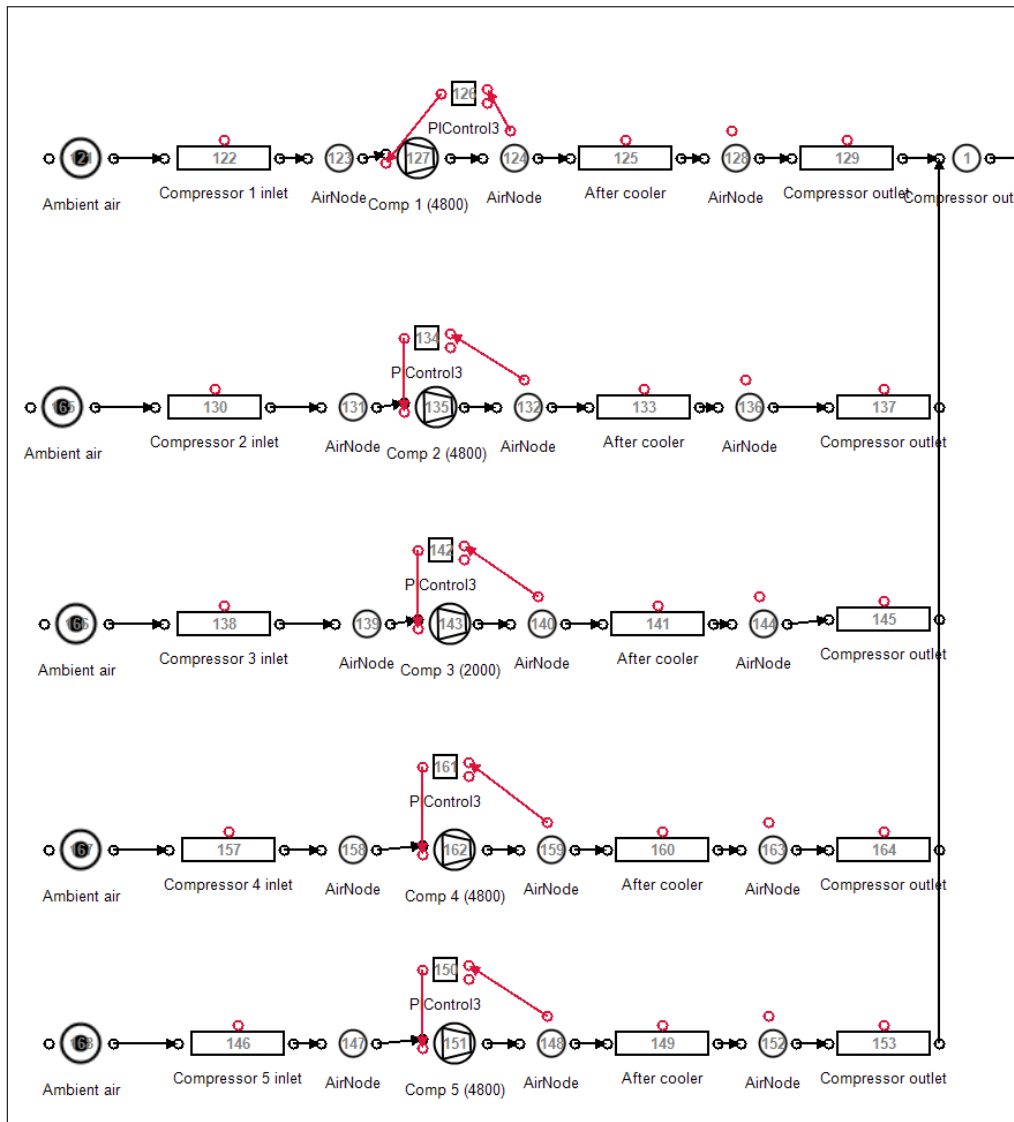

Figure I.3: Mine B simulation schematic – Compressors

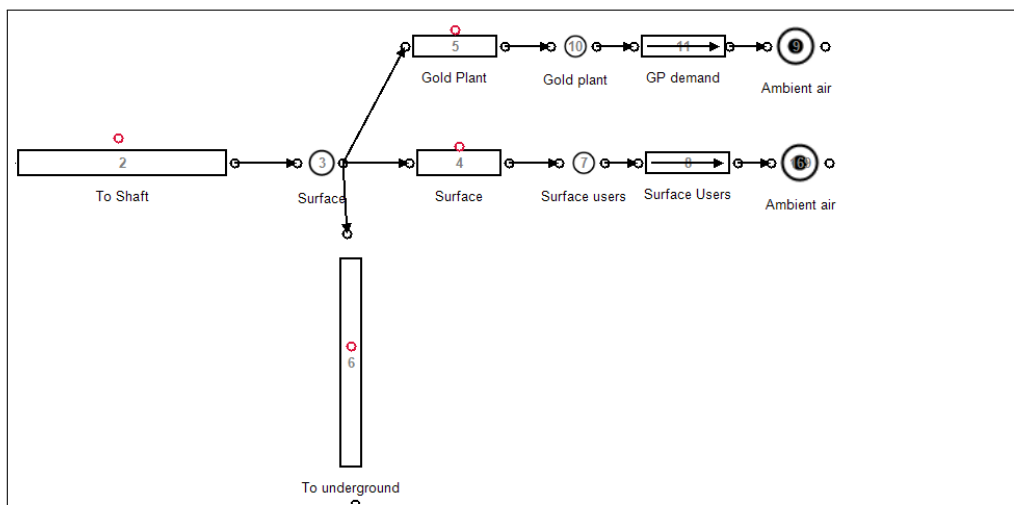

Figure I.4: Mine B simulation schematic – Surface air users

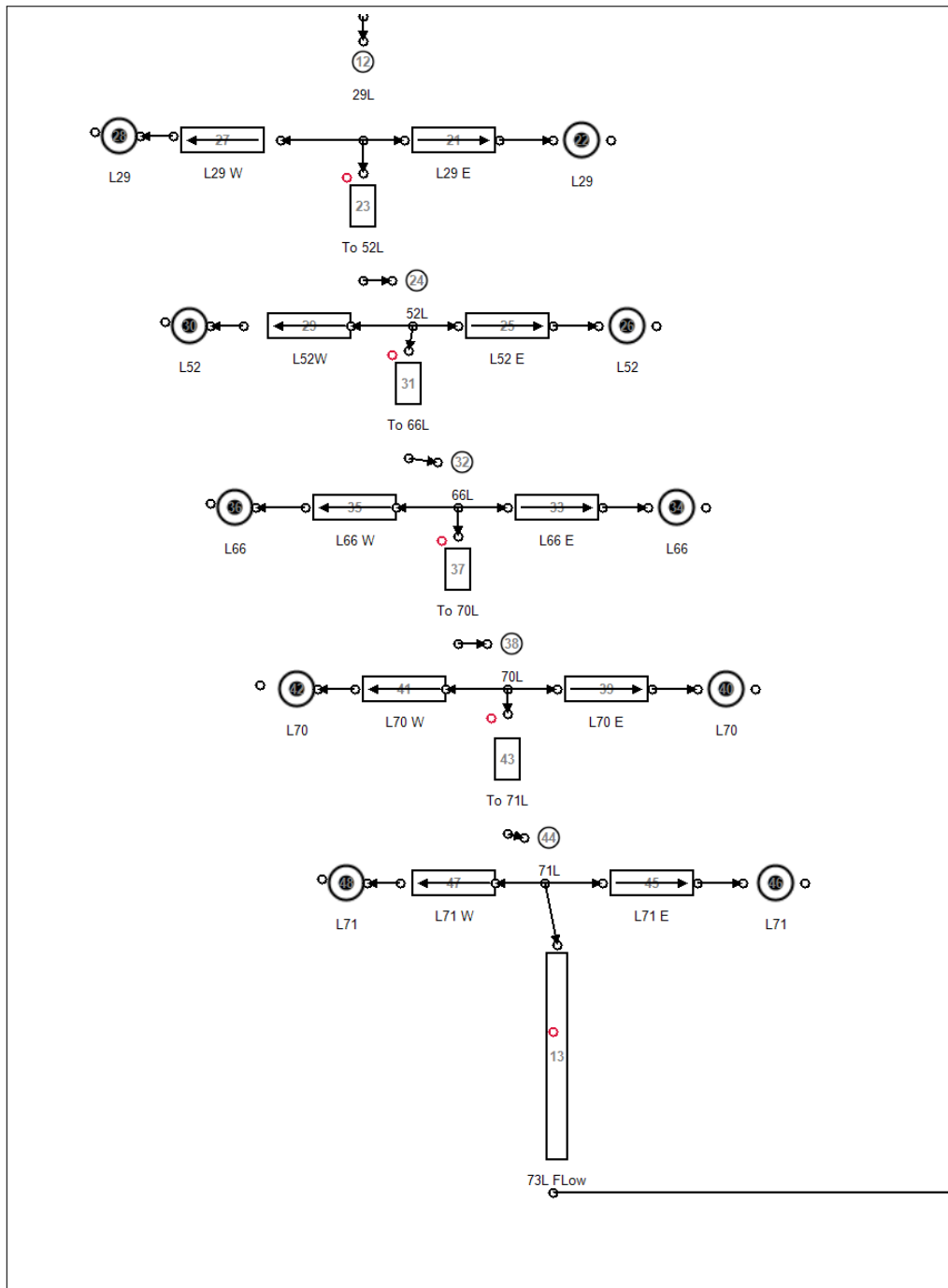

Figure I.5: Mine B simulation schematic – Main shaft air users

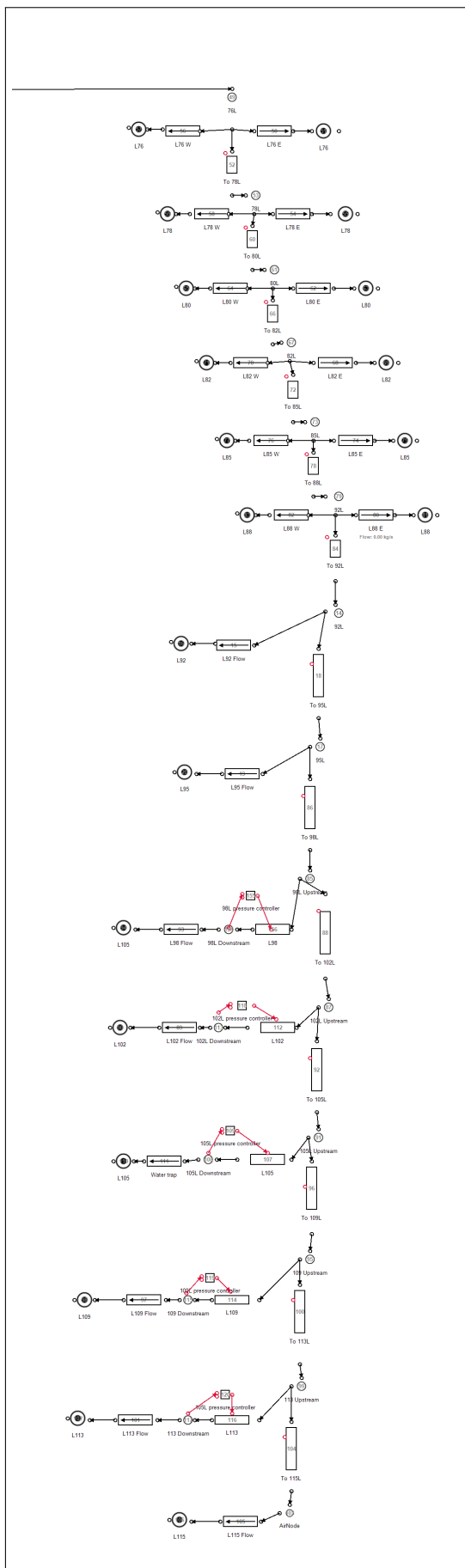

Figure I.6: Mine B simulation schematic – Sub-shaft air users

APPENDIX II

Error Calculations

The mean residual difference (\bar{R}), Mean Absolute Error (MAE) and the coefficient of determination were determined in the verification step of the methodology. The following calculation was utilised for total flow, power and compressor outlet pressure in each case.

$$\text{Mean residual difference } (\bar{R}) = \left| \frac{1}{720} \sum_{n=1}^{720} (A_n - S_n) \right| \quad (\text{II.1})$$

$$\text{Mean absolute error } (MAE) = \frac{1}{720} \sum_{n=1}^{720} |A_n - S_n| \quad (\text{II.2})$$

$$r = \frac{\sum_{n=1}^{720} (A_n - \bar{A})(S_n - \bar{S})}{\sqrt{\sum_{n=1}^{720} (A_n - \bar{A})^2 \cdot \sum_{n=1}^{720} (S_n - \bar{S})^2}} \quad (\text{II.3})$$

A simulation resolution of 2 minutes relates to $N = 720$ for a 24 hour simulation period.

Table II.1: Error calculation input data

n	Actual (A)	Simulation (S)
1	A_1	S_1
2	A_2	S_2
3	A_3	S_3
...
...
...
718	A_{718}	S_{718}
719	A_{719}	S_{719}
720	A_{720}	S_{720}

APPENDIX III

Model components verification

Table III.1: Case Study 1: Simulation model verification tables

Component	Actual Ave.	Simulated Ave.	Accuracy
Power (<i>kW</i>)			
VK-32 1	0	0	100%
VK-32 2	460	477	96.35%
VK-32 3	142	117	82.31%
VK-32 4	428	408	95.45%
VK-32 5	1813	1903	95.03%
VK-32 6	732	725	99.01%
VK-10 1	744	745	90.02%
VK-10 2	687	635	92.24%
System	4940	4911	97.34%
Flow (<i>kg/s</i>)			
1# 15L	1.45	1.42	97.87%
1# 16L	2.15	2.18	98.48%
1# 17L	0.34	0.35	97.30%
1# 18L	0.38	0.39	97.39%
1# 19L	0.31	0.31	98.77%
1# 20L	0.12	0.13	92.65%
2# 23L	1.31	1.35	96.69%
3# 21L	0.67	0.66	98.68%
3# 22L	0.74	0.67	89.54%
3# 23L	0.04	0.04	98.72%
3# 24L	0.11	0.11	98.76%
3# 25L	0.33	0.33	99.95%
3# 26L	0.45	0.47	95.07%
Gold Plant	2.59	2.48	95.72%
Total	9.32	9.51	97.01%

Table III.2: Case Study 2: Simulation model verification

Component	Actual Ave.	Simulated Ave.	Accuracy
Pressure (<i>kPa</i>)			
1# 15L	394	384	98.55%
1# 16L	421	419	99.61%
1# 17L	345	344	99.81%
1# 18L	336	336	99.99%
1# 19L	311	309	99.53%
1# 20L	368	368	99.90%
2# 23L	365	327	91.25%
3# 21L	303	302	99.92%
3# 22L	332	301	95.42%
3# 23L	332	332	99.98%
3# 24L	413	409	99.10%
3# 25L	413	409	99.01%
3# 26L	515	509	98.99%
Surface	502	501	99.95%

Table III.3: Case Study 2: Simulation model verification continued

Component	Actual Ave.	Simulated Ave.	Accuracy
Power (<i>kW</i>)			
Compressor 1	3406	3669	92.37%
Compressor 2	3911	3668	93.92%
Compressor 3	1440	1453	99.05%
Compressor 4	0	0	100%
Compressor 5	3299	3274	99.22%
System	12057	12103	98.73%
Flow (<i>kg/s</i>)			
95L	1.51	1.42	93.95%
98L	3.75	3.53	93.99%
102L	2.97	2.79	98.72%
105L	5.65	5.71	98.84%
109L	3.57	3.37	94.27%
113L	5.09	4.84	95.05%
Gold Plant	1.41	1.35	95.14%
Sub-shaft total	34.12	34.76	98.09%
Total	41.65	41.43	98.96%
Pressure (<i>kPa</i>)			
Surface	393	396	99.02%

APPENDIX IV

Detailed mining level investigation diagrams

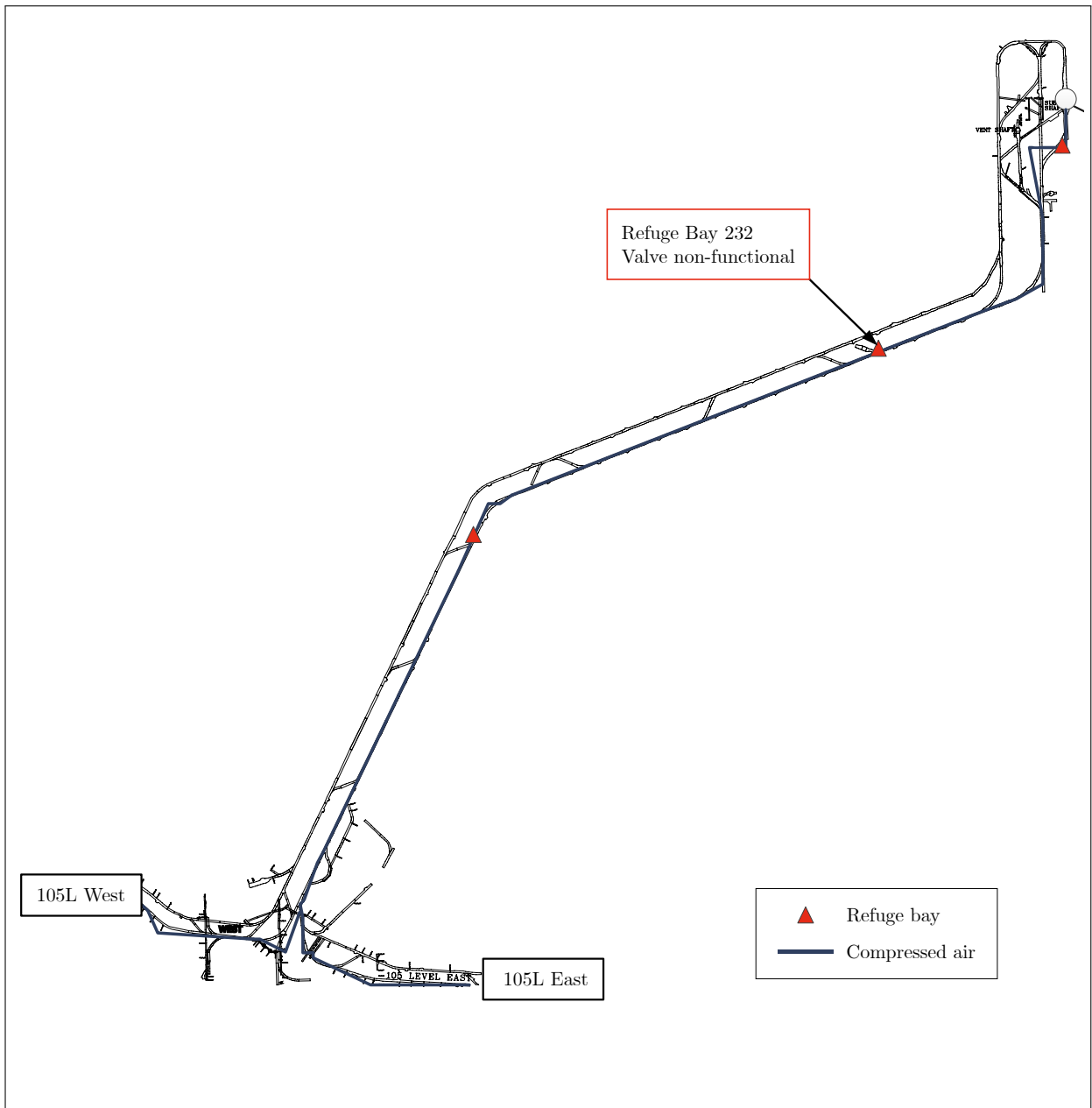

Figure IV.1: 105 Level investigation – Station

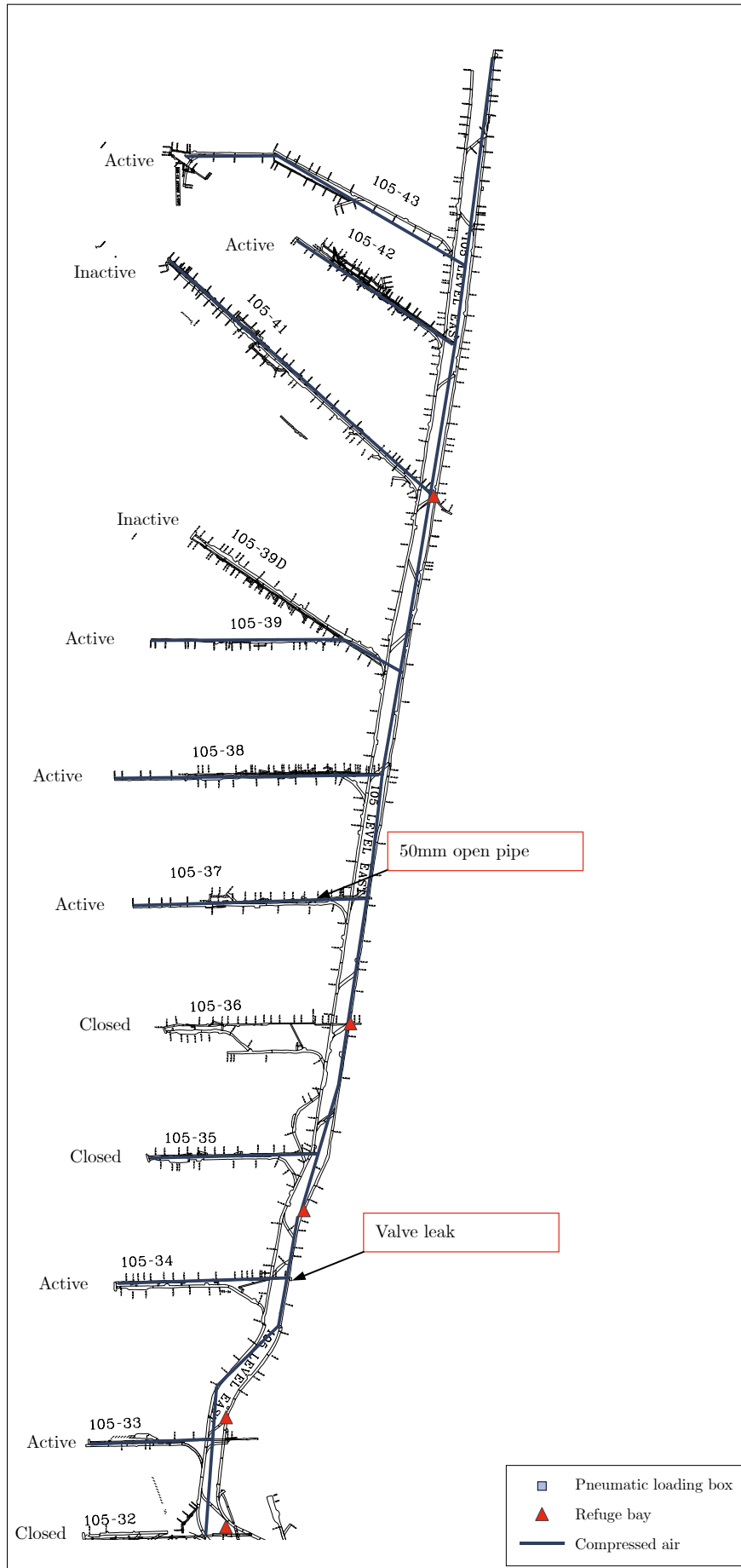

Figure IV.2: 105 Level investigation – West operations

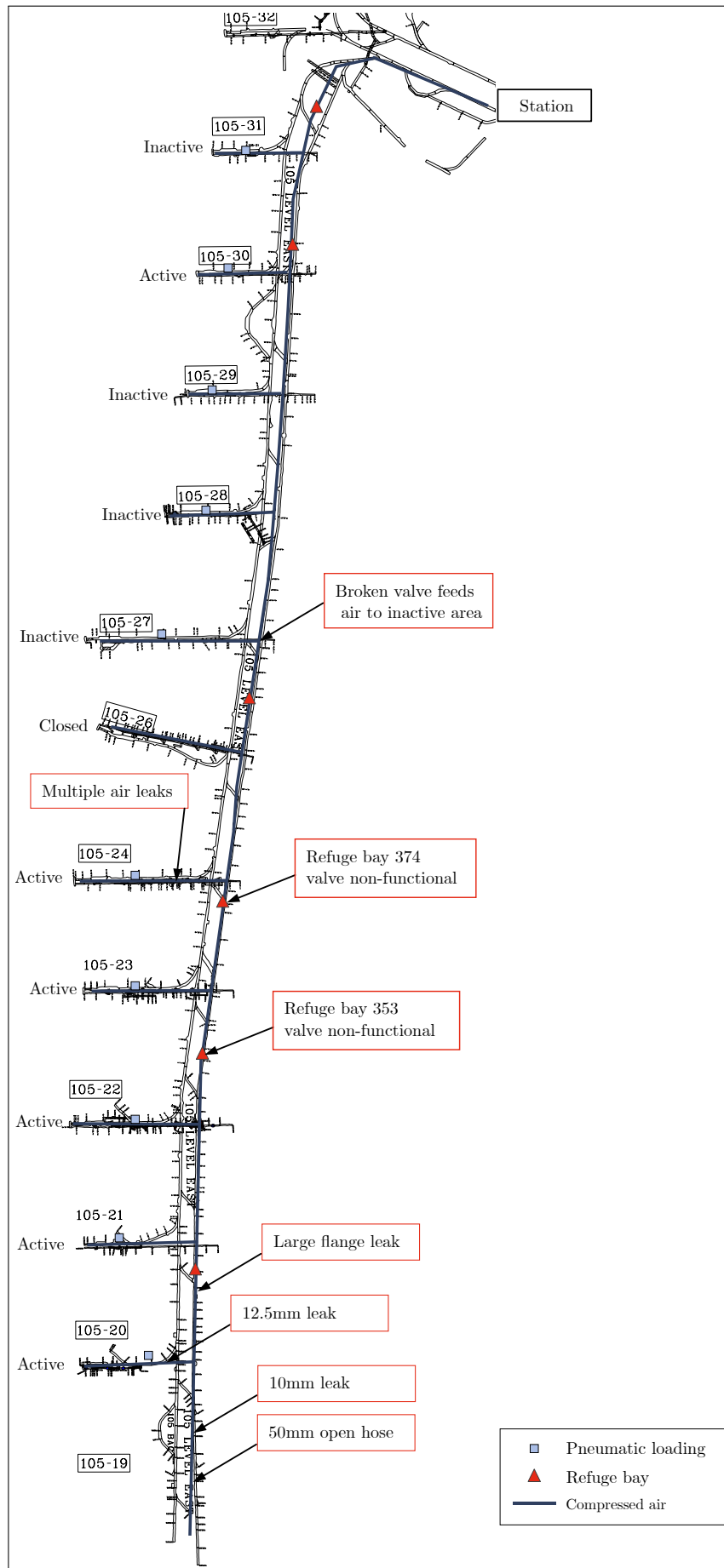

Figure IV.3: 105 Level investigation – East operation